

FLX Stix HDV

LED for Display, Cabinet, Furniture & Cove

Little light, Bigger punch!!



- 폭 16mm의 얇은 외형의 High Output 제품
- 쉽고 빠르게 연결 가능한 제품
- 브래킷 또는 자석을 이용하여 간단하게 탈부착 가능
- 사용 가능한 부속품으로 디밍 연출 가능





FLX Stix HDV
High Output

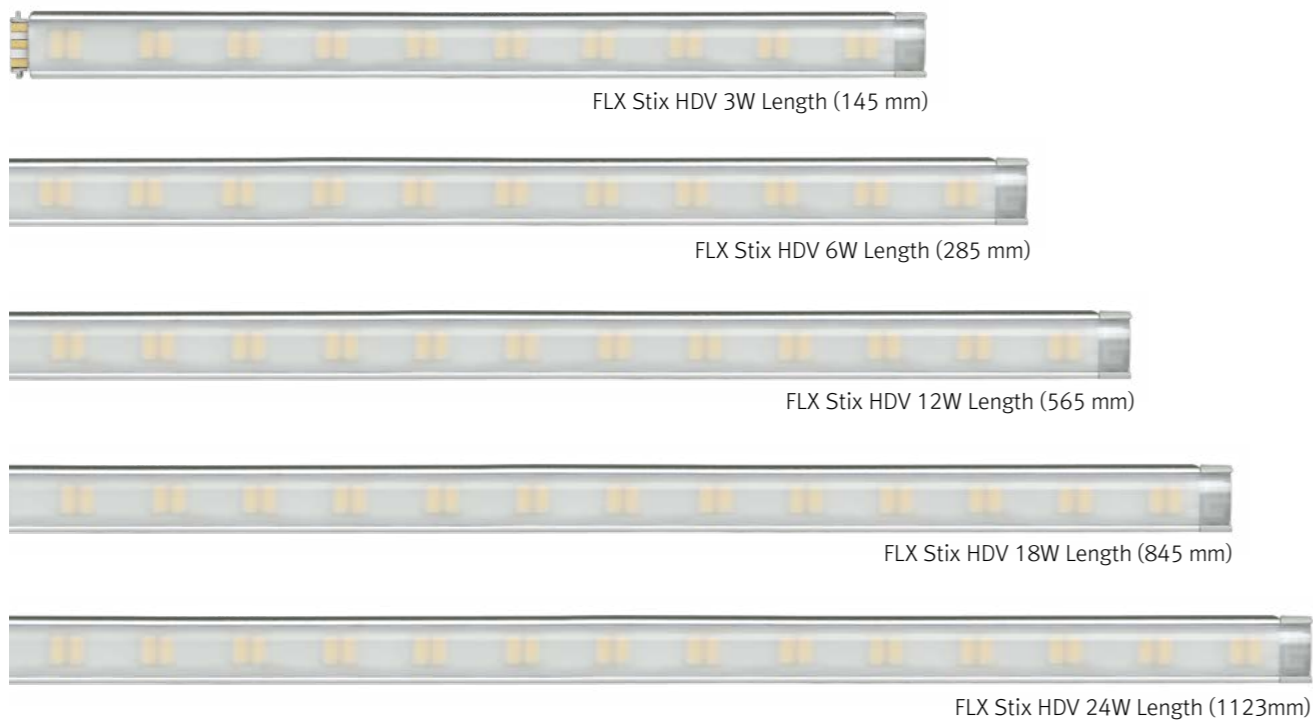

다양한 특징

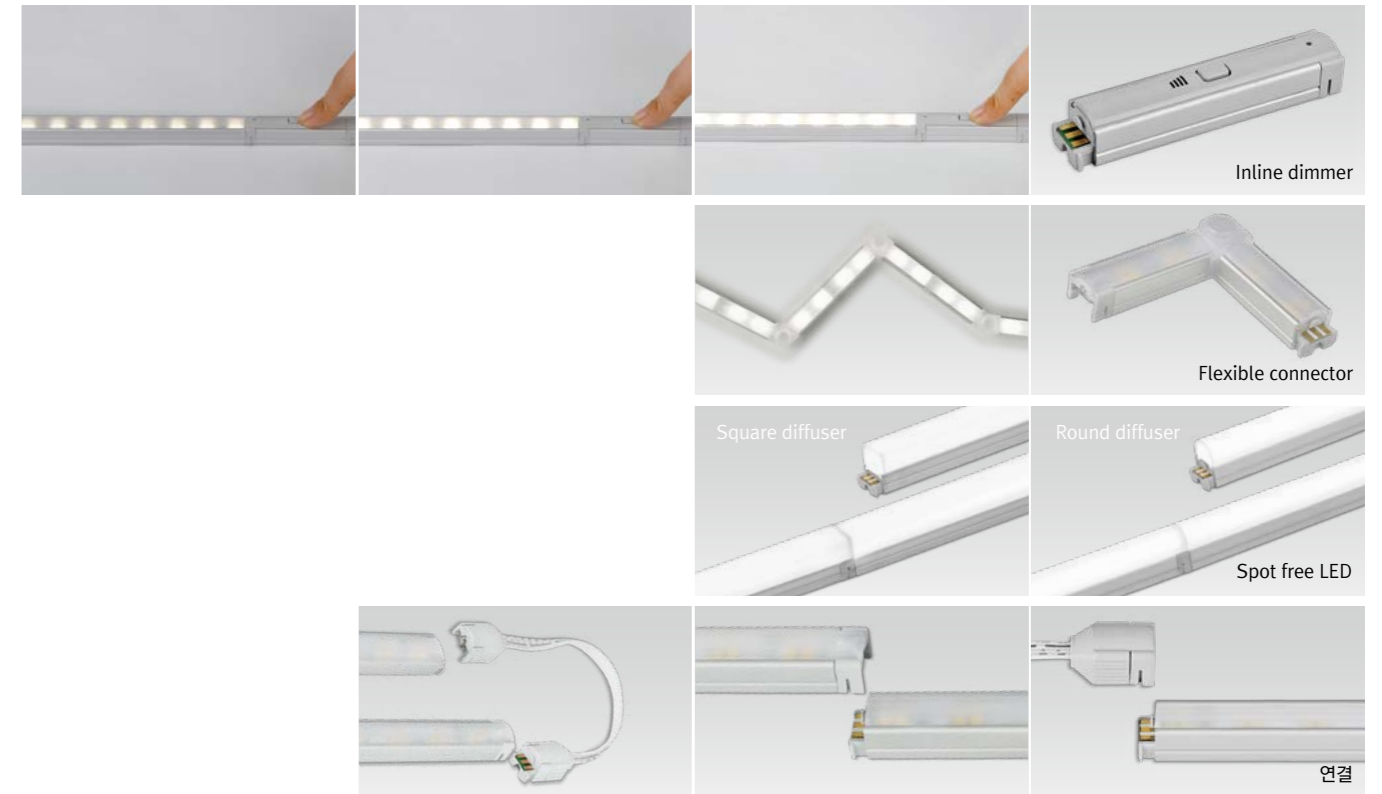

설치방법

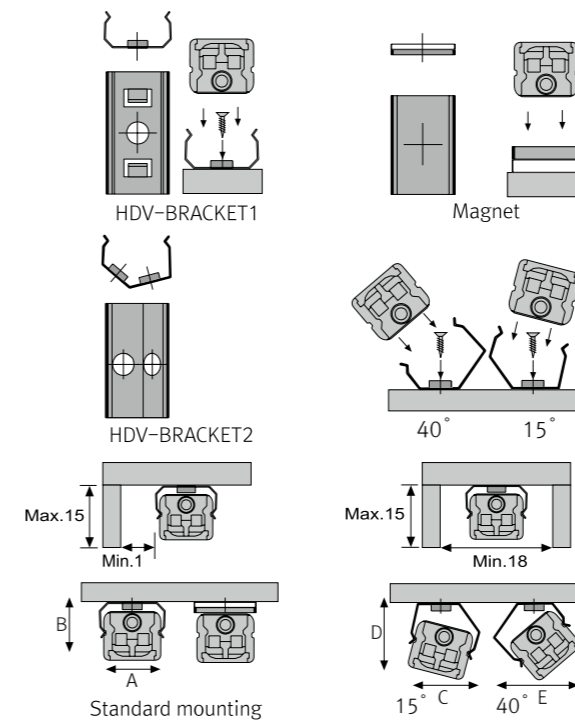

주의

- 최대연결 : 직렬 연결시 최대 75W

제품명	컨버터 별 최대 연결개수		
	24V/30W	24V/75W	24V/200W
HDB 3AB24NM/KE	8	24	54
HDB 6AB24NM/KE	4	12	27
HDB 12AB24NM/KE	2	6	14
HDB 18AB24NM/KE	1	4	9
HDB 24AB24NM/KE	1	3	7

- 브라켓 설치 후 규격

	A(mm)	B(mm)	C(mm)	D(mm)	E(mm)	F(mm)
Flat type	16.8	14.2	17.5	16.5	19.1	17.5
Round type	16.8	22.1	18.8	24.4	23.4	22.9
Square type	16.8	22.6	21.3	26.2	25.7	25.7

사양

제품명	입력전압	소비전력	광속	광효율	연색성	색온도	사용온도
HDB 3AB24NM/KE	DC24V	3W	240 lm	80 lm/W	Ra > 85	3,000K/4,000K/5,700K	0~45°C
HDB 6AB24NM/KE	DC24V	6W	480 lm	80 lm/W	Ra > 85	3,000K/4,000K/5,700K	0~45°C
HDB 12AB24NM/KE	DC24V	12W	960 lm	80 lm/W	Ra > 85	3,000K/4,000K/5,700K	0~45°C
HDB 18AB24NM/KE	DC24V	18W	1,440 lm	80 lm/W	Ra > 85	3,000K/4,000K/5,700K	0~45°C
HDB 24AB24NM/KE	DC24V	24W	1,920 lm	80 lm/W	Ra > 85	3,000K/4,000K/5,700K	0~45°C

규격

제품명	입력전압 (V)	소비전력 (W)	A (mm)	B (mm)	C (mm)	D (mm)	E (mm)	F (mm)	G (mm)
HDB 3AB24NM/KE	DC 24	2.9	140	145	162	16	15.5	15	12.5
HDB 6AB24NM/KE	DC24	5.8	280	285	302	16	15.5	15	12.5
HDB 12AB24NM/KE	DC 24	11.6	560	565	582	16	15.5	15	12.5
HDB 18AB24NM/KE	DC 24	17.4	840	845	862	16	15.5	15	12.5
HDB 24AB24NM/KE	DC 24	23.2	1,118	1,123	1,140	16	15.5	15	12.5

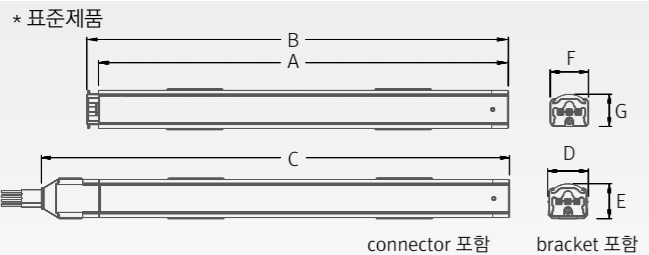

제품명	A (mm)	B (mm)	C (mm)
FLC30-24V/KR	150	41	31
FLC75-24V/KR	180	60	32

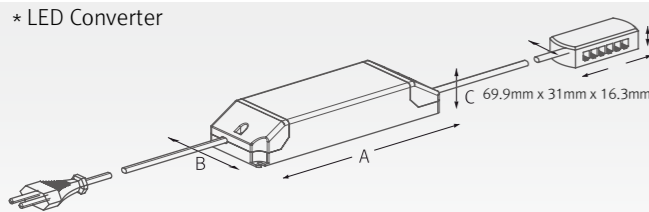

제품명	A (mm)	B (mm)	C (mm)
FLC150-24V-FDH	220	54	32
FLC200-24V-FDH	235	71	45
FLC300-24V-F	252	71	45

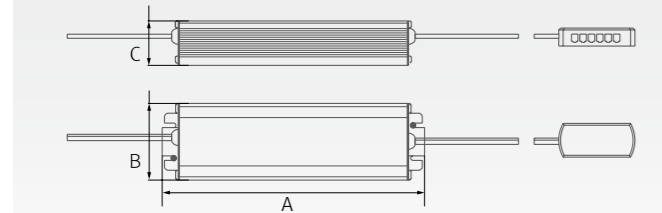

약세사리



① 연결선

HDBPTC	HDBPTC1	HDBPTC2	HDBPTC4	HDBPTC6
150mm	300mm	600mm	1,200mm	1,800mm

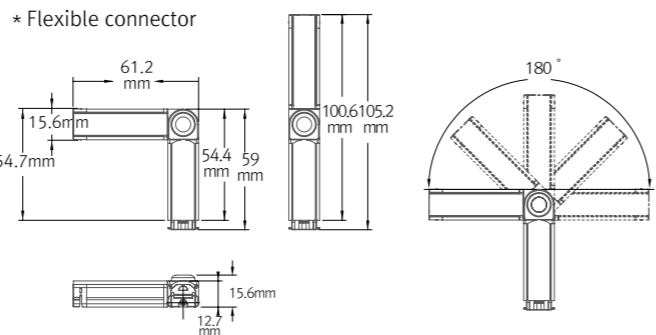
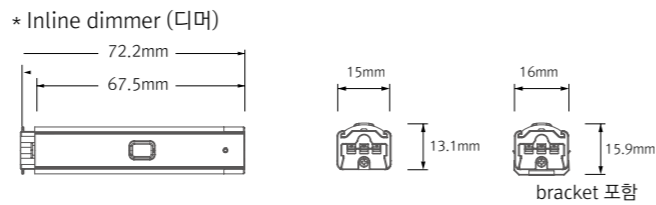
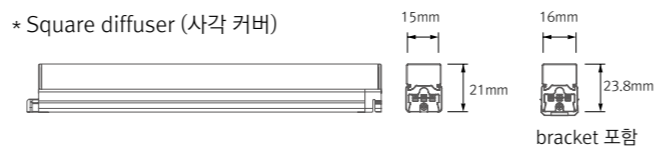
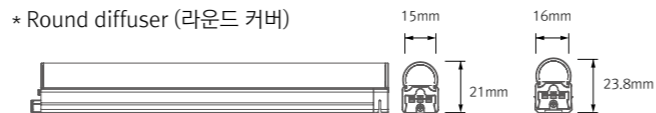

② 전원선 : HDBPC (2,500mm)



③ 고정클립 : HDB-BRACKET "A"

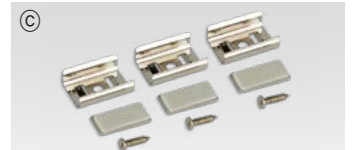

④ 각도클립 (15° & 40°) : HDV-BRACKET2 "A"



⑤ 측면 연결방식 (3W) : HDB 3A3B24NM/KE-S



⑥ Connector : HDB 2A3B24NM/KE-FLEX

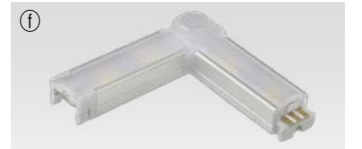

⑨ LED converter

Part No	FLC30-24V/KR	FLC75-24V/KR
Capacity	30W 24V	75W 24V



⑩ LED SMPS

Part No	FLC150-24V-FDH	FLC200-24V-FDH	FLC300-24V-F
Capacity	150W 24V	200W 24V (IP66)	300W 24V (IP66)



① Inline dimmer : FSE-L1D/KR (HDB DIM)

Max 75W in a row



① Round diffuser (라운드 커버)

HDV3CVRM	HDV6CVRM	HDV12CVRM	HDV18CVRM	HDV24CVRM
3W	6W	12W	18W	24W

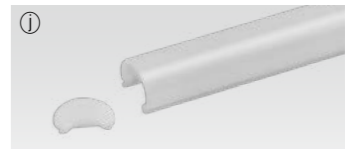

② Square diffuser (사각 커버)

HDV3CVSM	HDV6CVSM	HDV12CVSM	HDV18CVSM	HDV24CVSM
3W	6W	12W	18W	24W

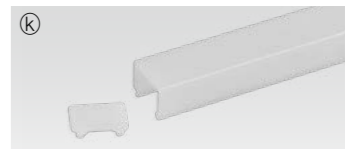

① 도어 및 동작감지센서 (DC) : FLS-M24V

Voltage : DC 24V



② 인체감지센서 (DC) : FLS-P24V

Voltage : DC 24V

