

# FLX Stix HDPPro(LINE)

Convenient and Simple Connection, HDPPro LINE



- 연결 부위에 Dark Spot 없음
- 고효율 라인 조명
- 쉽고 빠르게 연결 가능한 제품
- 브라켓 또는 자석을 이용하여 간단하게 탈부착 가능
- 연결 방식이 용이하여 시설 간접 조명으로 적합

## 다양한 특징

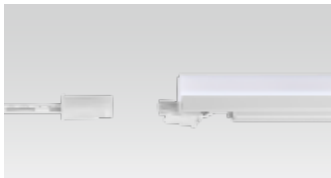

전원선 연결



제품 연결

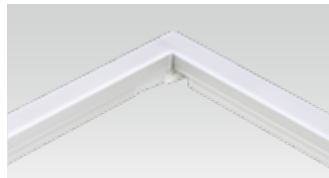

90° 연결

## 사양

제품명	입력전압	소비전력	광속	광효율	연색성	색온도	사용온도
HDPW2 57K-24V-C90	DC24V	2W	150lm	70lm/W	Ra>90	2,700K/3,000K/3,500K/4,000K/5,700K	0~45℃
HDPW3 57K-24V-C90		3W	200lm				
HDPW6 57K-24V-C90		6W	400lm				
HDPW12 57K-24V-C90		12W	900lm				
HDPW18 57K-24V-C90		18W	1,300lm				
HDPW24 57K-24V-C90		24W	1,700lm				
HDPW2 57K-24V-C90		2W	150lm				
HDPW4 57K-24V-C90		4W	300lm				
HDPW7.5 57K-24V-C90		7.5W	600lm				
HDPW11 57K-24V-C90		11W	800lm				
HDPW15 57K-24V-C90		15W	1,200lm				

**규격**

\* 표준제품

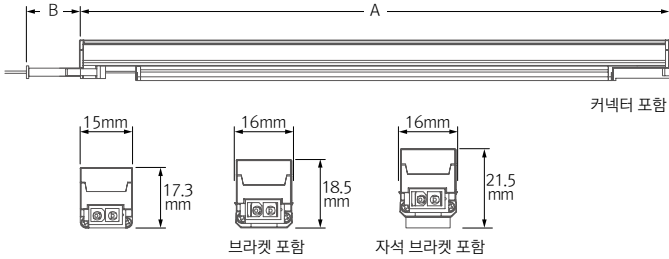

\* Round Cover 형 제품

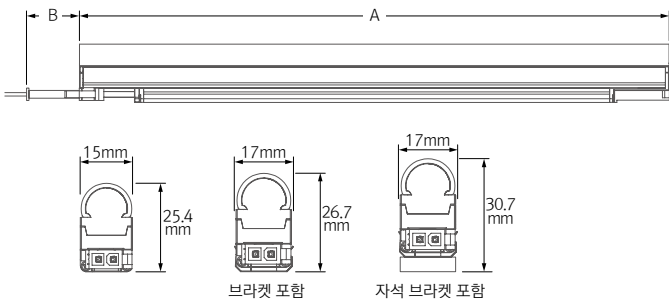

사이즈	A (mm)	B (mm)
HDPW2 57K-24V-C90	72	23
HDPW3 57K-24V-C90	140	
HDPW6 57K-24V-C90	280	
HDPW12 57K-24V-C90	559	
HDPW18 57K-24V-C90	838	
HDPW24 57K-24V-C90	1,117	
HDPW2 57K-24V-C90	140	
HDPW4 57K-24V-C90	280	
HDPW7.5 57K-24V-C90	559	
HDPW11 57K-24V-C90	838	
HDPW15 57K-24V-C90	1,117	

**악세서리**

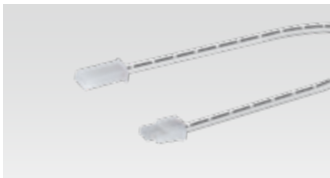

**연결선 : HDPWPTC**  
 · HDPWPTC : 150mm  
 · HDPWPTC1 : 300mm  
 · HDPWPTC2 : 600mm

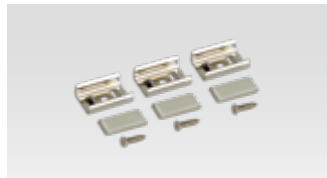

**고정 브라켓 : HDB-BRACKET1**



**오픈 전원선 : HDPWOPC**  
 · 1,000mm / 2,000mm



**각도 브라켓 : HDV-BRACKET2**  
 · 각도 (15°, 45°)

**배광**

HDPW15 57K-24V-C90

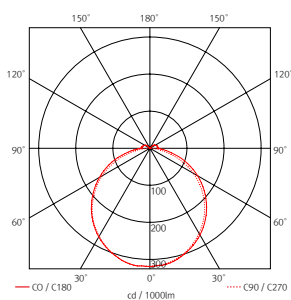

HDPW24 57K-24V-C90

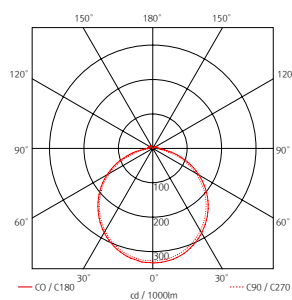

**주의**

- 최대연결 : 직렬 연결시 최대 120W / 컨버터 용량의 80% 이하 설치

제품명	컨버터별 최대 연결 개수		
	24V/30W	24V/75W	24V/200W
HDPW2 57K-24V-C90	15	36	80
HDPW3 57K-24V-C90	10	24	54
HDPW6 57K-24V-C90	5	12	27
HDPW12 57K-24V-C90	2	6	14
HDPW18 57K-24V-C90	1	4	9
HDPW24 57K-24V-C90	1	3	7