

Installation instructions

FEELUX DIMSUM

AC 120V 60Hz

HE Type DSL14 AB12NN - 14W 0.145A

DSL21 AB12NN - 21W 0.208A

DSL28 AB12NN - 28W 0.284A



PORTABLE CABINET LUMINAIRE
73LF

This portable cabinet light has a polarized plug (one blade is wider than the other) as a feature to reduce the risk of electric shock. This plug will fit in a polarized outlet only one way. If the plug does not fit fully in the outlet, reverse the plug. If it still does not fit, contact a qualified electrician. Never use with an extension cord unless plug can be fully inserted. Do not alter the plug.

Mounting Dimensions

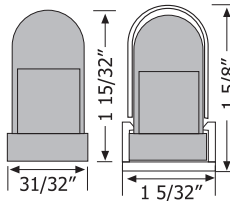
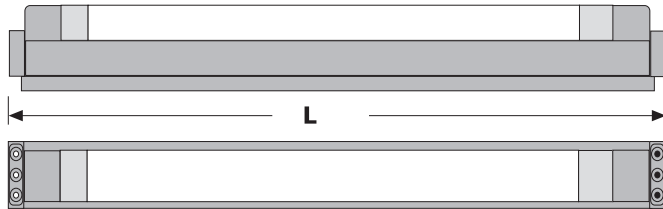

Fig. 1

Fig. 2

Lamp: T5 HE fluorescent lamp

	Wattage	Length "L"	Maximum units
DSL14	14 Watt	23 7/16"	10 units
DSL21	21 Watt	35 4/16"	10 units
DSL28	28 Watt	47 1/16"	10 units

Total lamp wattage in one lighting row
Maximum 10 pcs per line and Maximum 600W irrespective of channel.

Mounting Arrangements

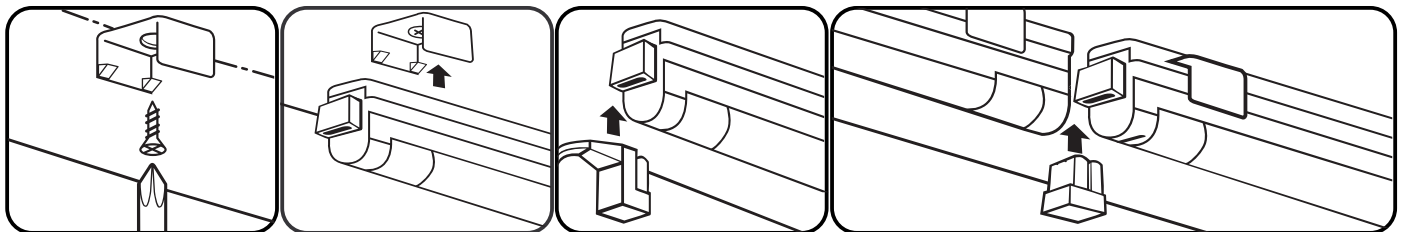

Step One

Install mounting clips with enclosed screws.

Step Two

Snap or slide lamp into the clips. Handle with care to avoid breaking the lamp.

Step Three

Connect power cord to AC in end of lamp. Plug in. (Cord not included).

Step Four

Multiple lamps can be attached using 1/2" coupler (not included), or spaced from 6" to 6' using connecting cables (not included).

Max. permitted ambient temperature : 45 °C

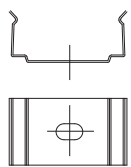

Mounting clip
Fig. 4

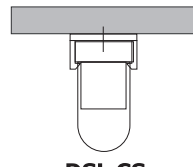

DSL CS
Standard mounting
Fig. 5

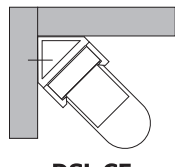

DSL CE
Corner mounting
Fig. 6

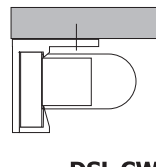

DSL CW
angular configuration
Fig. 7

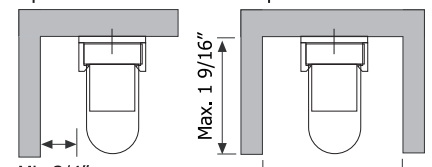

Fig. 6

Fig. 7

Lamp Replacement

Attention : Only use T5 HE fluorescent lamp!

Fig. 8

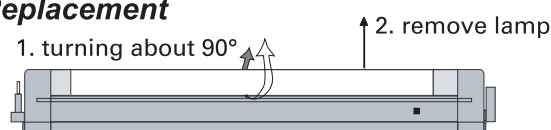

Isolate luminaire(s) from the supply! The fluorescent lamp can now be removed after turning about 90°. After fitting the new lamp, the lamp must be pushed back into their original position.

Installation Instructions " IMPORTANT SAFETY INSTRUCTIONS "

"CAUTION" To Reduce The Risk Of Fire, Electric Shock Or Injury To Persons;

- Use Only insulated staples or plastic ties to secure cords.
- Route and secure cords so that they will not be pinched or damaged when the cabinet is pushed to the wall.
- Position cabinet light with respect to cabinet so as to permit reading of the lamp replacement markings during relamping.
- Not intended for recessed installation in ceilings or soffits.
- Not intended for surface installation inside built in furnishings such as kitchen cabinets, china cabinets or trophy cases.
- The portable cabinet light may be installed under a kitchen cabinet when the power supply cord is not concealed or run through openings in the cabinet.
- Do not conceal power supply cord (or power supply) inside wall, ceiling soffits, kitchen cabinet, or similar permanent structure.
- Do not run the power supply cord through holes in walls, ceilings, or floors.
- The portable cabinet light may be installed inside a kitchen cabinet or other built-in furnishing provided that the cabinet or built-in furnishing is provided with a dedicated receptacle and the power supply cord is not concealed or run through openings in the cabinet or built-in furnishing.

Note - Instruction (i) is optional.

PLEASE CALL TOLL FREE 800-983-3346 for assistance if needed
No part of this publication may be reproduced without the prior permission of the publishers.

FEELUX 2875 North Berkeley Lake Rd.
NW Suite 17 Duluth, GA 30096

Installation instructions

FEELUX DIMSLIM

AC 120V 60Hz

HE Type DSL14 AB12NN - 14W 0.145A

DSL21 AB12NN - 21W 0.208A

DSL28 AB12NN - 28W 0.284A



PORTABLE CABINET LUMINAIRE
73LF

Dimmable lighting system for exhibitions and shop-fitting and as lighting row luminaire with through-wiring and integral plug connectors.

Installer Instructions for Hardwirebox

"This "Installer instruction for Hardwire box" is for reference only. The Hardwire box is not part of our product"

- Step1. Select one of the 1/2" Knockouts that will be used for wiring the box and snap it out with a flat head screwdriver
- Step2. Remove the three screws from the top of the box and over the top off. Select an appropriate bushing for the type of 1/2" trade conduit or wiring that will be used. Install the bushing in the knockout selected.
- Step3. Mount the box with appropriate screws or fasteners to the mounting surface using the four counter sunk holes in the bottom.
- Step4. Replace the box top and secure with the three screws. Connect the conduit to bushing if conduit was used.
- Step5. Connect the first DIMSLIM Portable luminaire to the connector on the box with one of the interconnecting cords.

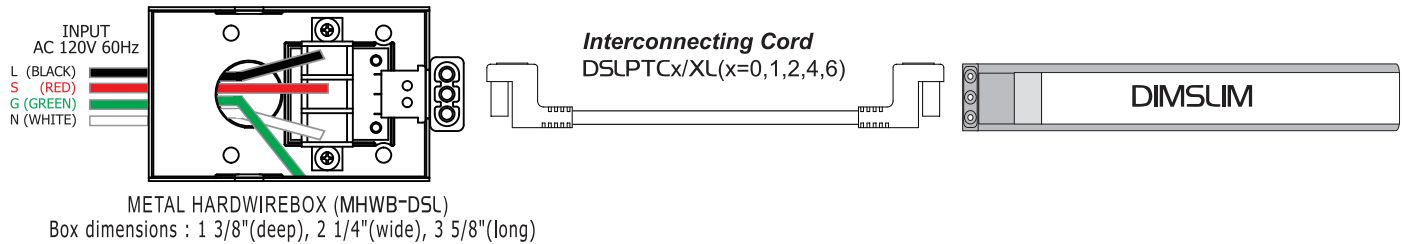

Installer Instructions for Dimming System

"This "Installer instruction for Dimming System" is for reference only. The Dimmer is not part of our product"

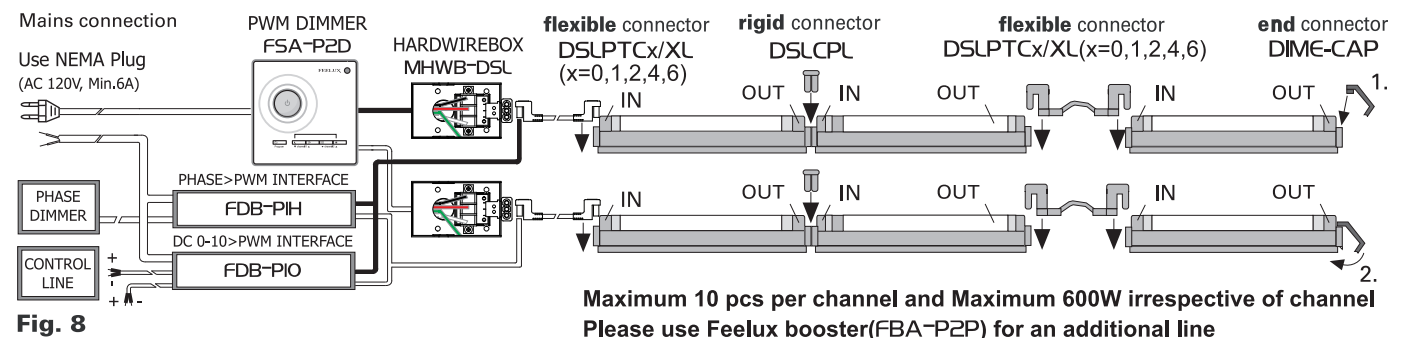

Fig. 8

The direction of the supply must be observed prior to installation (IN...OUT). Fixing of the luminaires takes place via mounting clips. These must be fixed at the required point with a wood screw and the luminaire can be snapped in place. Impress the cover carefully at OUT at the last luminaire of a lighting row and fix it.

Mounting Instructions

The units shall be attached to a mounting surface such as metal or wood, and if attached to drywall, the screws shall penetrate the drywall and still allow 1/2 inch to penetrate stud.

DIMSLIM Portable luminaire should be installed on a circuit free of inductive loads.

Due to the Electronic Ballast the DIMSLIM Portable luminaire may sustain damage if connected to a power source which has sparks or surges in excess of 1,000 volts. In this event R1 resistor fails the Portable Luminaire is not repairable. In locations where DIMSLIM Portable luminaire fail frequently a surge protector should be installed to the power supply.

The equipment to monitor the power source for sparks and surges is expensive and very time consuming. If the installation of the surge protector eliminates the failures this indicates the failures are due to voltage surges and sparks. Failure to use surge protection in problem areas will void the DIMSLIM Portable luminaire Warranty.

Warning Information

This product is for indoor use only. Fitting and removal must take place only with the supply disconnected. Permanent mains connection must be undertaken only by a qualified specialist. Only replace faulty parts with original parts. If the external flexible cable or cord of this luminaire is damaged, it shall be replaced by a special cord or cord exclusively available from the manufacturer, his service agent or a qualified specialist.

Meaning of crossed-out wheeled dustbin: Do not dispose of electrical appliances as unsorted municipal waste, use separate collection facilities. Contact your local government for information regarding the collection systems available. If electrical appliances are disposed of in landfills or cumps, hazardous substances can leak into the groundwater and get into the foodchain, damaging your health and well-being. When replacing old appliances with new ones, the retailer is legally obligated to take back your old appliance for disposal at least free of charge.

Attention : The connection and the dimming of the Feelux DIMSLIM is possible with Feelux Controller FSA-P2D, FDB-PIO and FDB-PIH exclusively. No warranty will be given when used with any dimmer or dimmer switch other than supplied and authorized by Feelux.

PLEASE CALL TOLL FREE 800-983-3346 for assistance if needed
No part of this publication may be reproduced without the prior permission of the publishers.

FEELUX 2875 North Berkeley Lake Rd.
NW Suite 17 Duluth, GA 30096