

DATE **PROJECT** **TYPE**



PRODUCT FEATURES

PRODUCT SPECIFICATIONS

- Seamless Spot Free Illumination
- Ultra Slim
- Close Pitch LEDs
- Bend Direction Vertically
- Dimmable
- Indoor and Outdoor Application
- Tunable color range 2,200K-4,000K
- Field Cut-able (38.5mm)
- Available in Standard Lengths of 1,2,3,4,5M Reels

IP Rate	IP67 with Factory Termination (Customized Length Available)
	IP65 with Field Termination
Lamp Power	5.9W/ft
Power Input	24V DC
Color Rendering	Ra>80
Operating Temperature Ranges	-10°C to 50°C
Maximum Length	5,000mm
Minimum Length	50mm
Minimum Bending Diameter	100mm
Beam Angle	130°
Material	PVC

SPECIFICATIONS TABLE



Model Name	Power Input	Lamp Power	Luminous Flux (Full Brightness)	Color Temperature
FN2 SC-24V-1M	DC 24V	19.2 W	867 lm	2,200K-4,000K

PHYSICAL SPECIFICATIONS

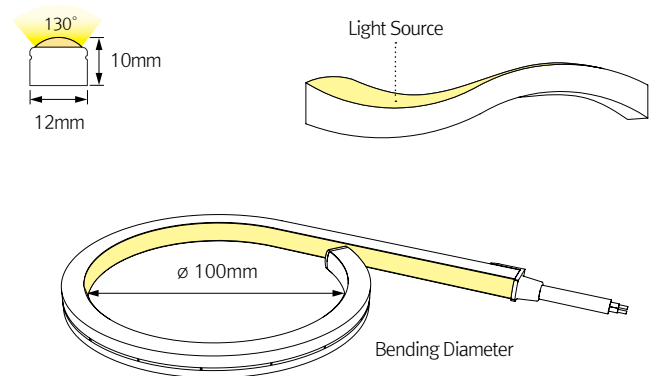

DIMENSIONS

TOP VIEW

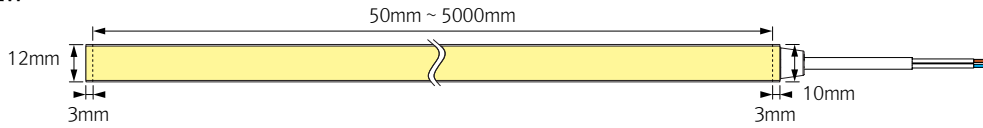

SIDE VIEW

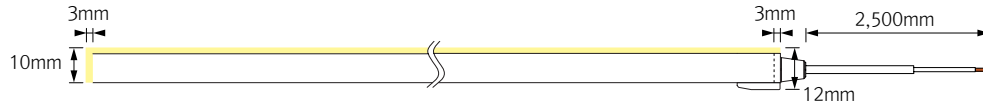

BOTTOM VIEW

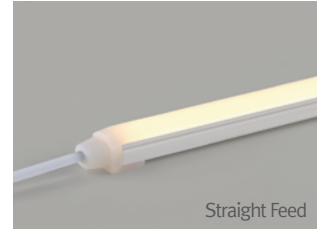
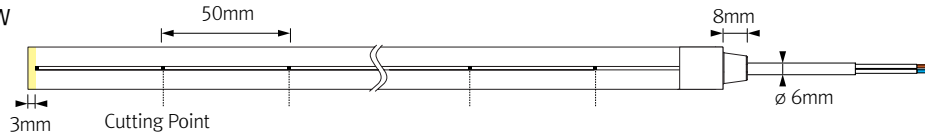

TOP VIEW

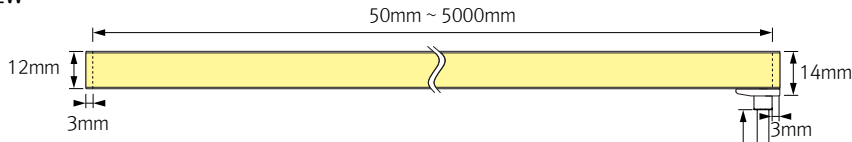

SIDE VIEW

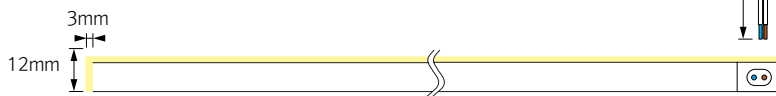

BOTTOM VIEW

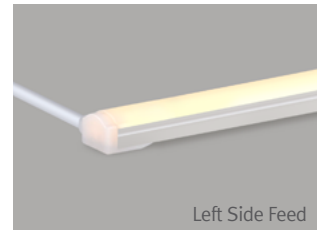
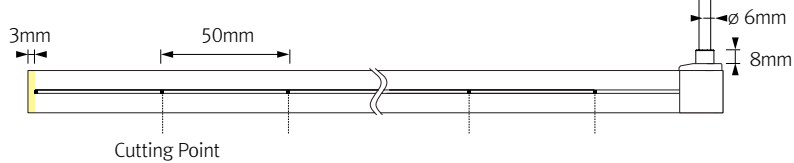

TOP VIEW

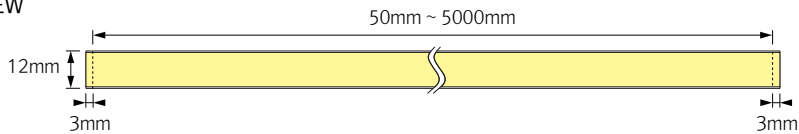

SIDE VIEW

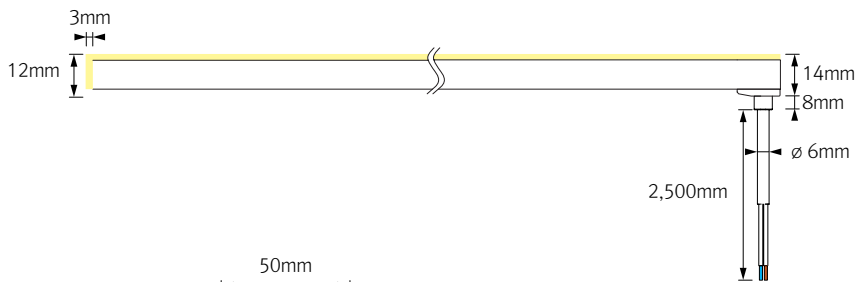

BOTTOM VIEW

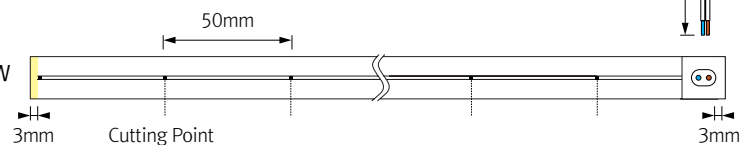

FLXible Neon can be cut every 50mm.
Please follow the cutting point mark to cut precisely as needed.

BEAM SPREADS

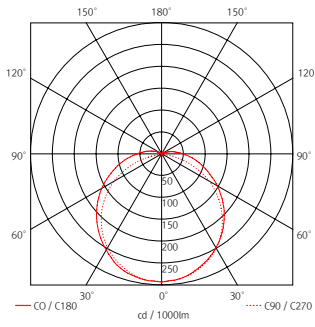

FN2 SC-24V-1M
45.2 lm/W
867 lm

INSTALLATION – Bracket

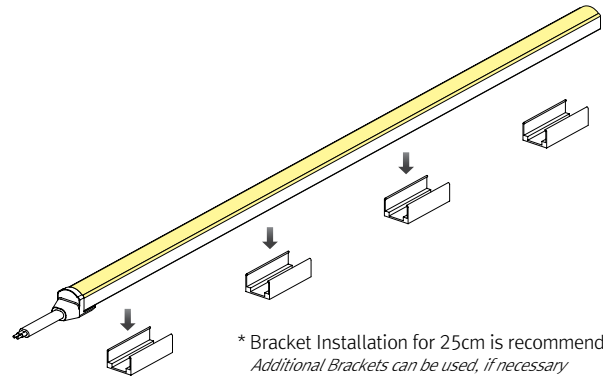

INSTALLATION – Field Termination (IP65)

* Components

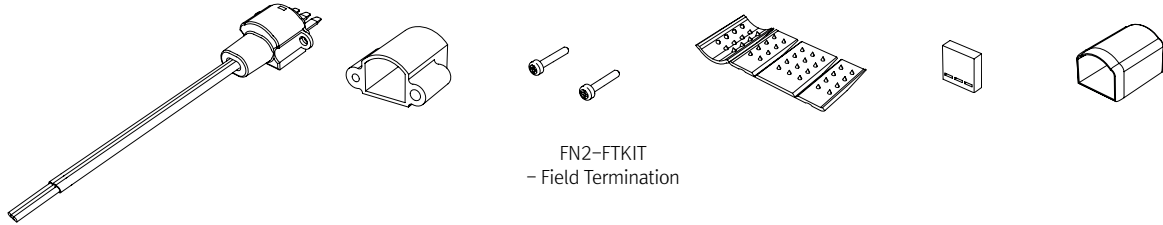

* Expanded View

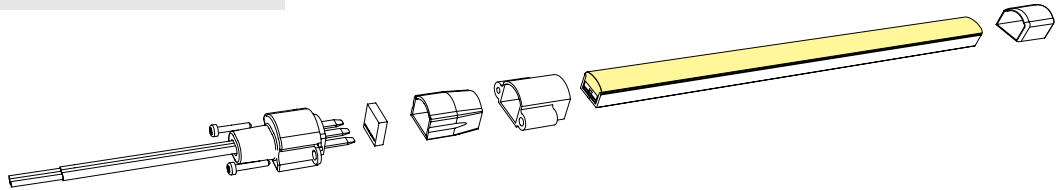

COMPONENTS



FLXible Neon 2
 __FN2-SC-24V-5m
 __FN2-SC-24V-4m
 __FN2-SC-24V-3m
 __FN2-SC-24V-2m
 __FN2-SC-24V-1m



Field Termination
 __FN2-FTKIT-DUAL

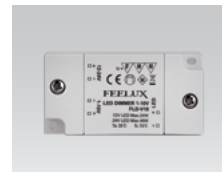

Dimming Interface (0-10V/1-10V)
 __FDC-L10 (Max. 100W)



Mounting Brackets
 __FN2-BRACKET1



12 Port Hub
 __12 Way distributor
 Included with Cord and Plug drivers. Order separately for 3rd Party Drivers



Dimming Interface
 __FDA-L2MO
 (0-10V/1-10V, DMX512)
 Max. 200W (100W/CH, 2CH)
 __FDA-L5M (DMX512)
 Max. 200W (50W/CH, 5CH)

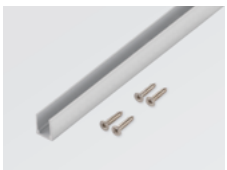

FN2 Extrusion Line
 __FN2-EXL (1,200mm)

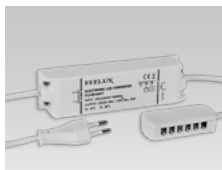

LED Drivers
 __FLC30-24V/T (30W)
 __FLC75-24V/T (75W)
 with distributor and power cord (1,800mm)



Dimming Interface (Dail)
 __FDD-L1DA
 Max. 200W (100W/CH, 1CH)



Expanding Stick
 __FN-EPS



LED Driver
 __FLC200-24V/T (200W)
 with 12way distributor