

MonoRail 2

Magnetic Lighting System for Display, Cove & Drywall

Modular Low Voltage Track System
with Flexibility and Creativity



- High-end Linear Fixture with Spot-Free illumination
- Mini Spotlight with various beam angle and dimming touch sensor
- Easy installation with magnetic track system
- Various aluminum track and components available.
- Optional illuminated power feed

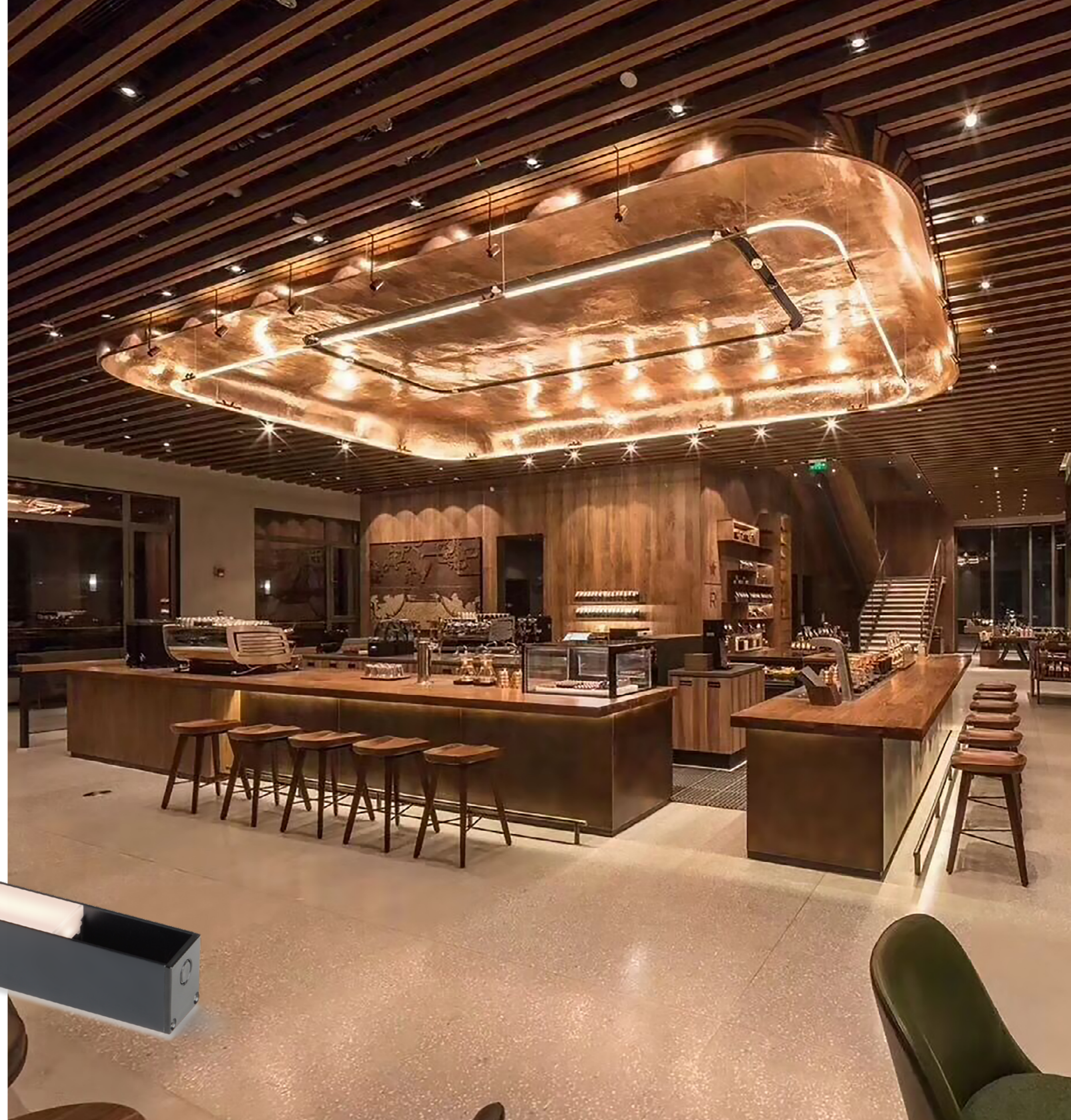



MonoRail 2
Display & Cove System for Long runs!



NMS3 / MonoRail 2 Spot



NMP3 / MonoRail 2 3W Length (97mm)



* NMP4 / MonoRail 2 4W Length (145mm)



* NMP8 / MonoRail 2 8W Length (288mm)

* For the direct connection between tracks use only 4W/8W fixture.

Various options

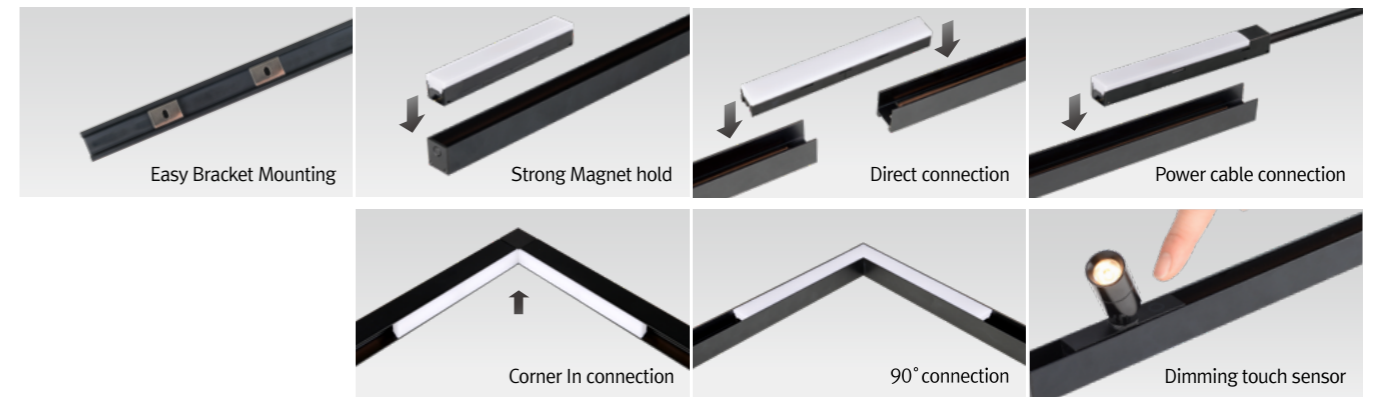

Track Types

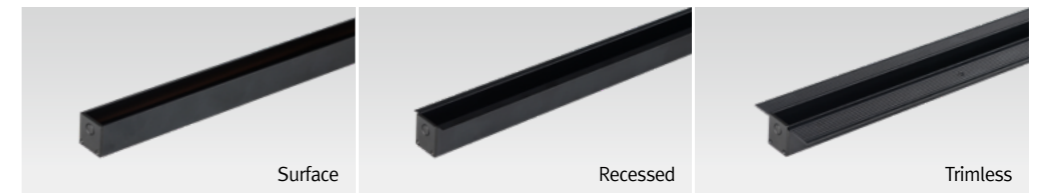

Installation

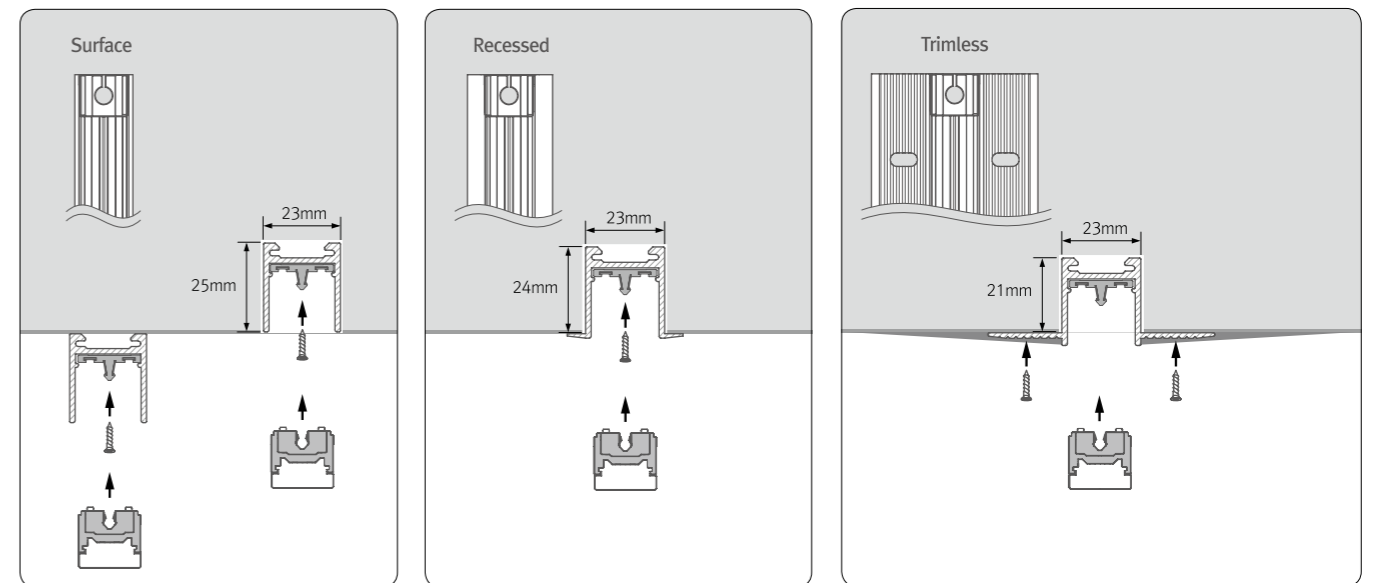

Max. connection

- MonoRail 2 : 180W in one row (Single power feed)
- LED Driver

Model Name	Max. units for LED Driver		
	24V/30W	24V/75W	24V/200W
NMS3 40K-24V	11	28	76
NMP3 40K-24V-C90	12	28	76
NMP4 40K-24V-C90	7	19	52
NMP8 40K-24V-C90	3	9	25

Specification

Model Name (4000K)	Power Input	Lamp Power	Lumens	Efficiency	Color Rendering	Available Color	Operating Temperature
NMS3 40K-24V-C90	DC 24V	2.8 W	230 lm	80lm/W	Ra>90	2,700K/3,000K/3,500K/4,000K	0 ~ 45°C
NMS3 40K-24V-C90-T	DC 24V	2.8 W	230 lm	80lm/W	Ra>90	2,700K/3,000K/3,500K/4,000K	0 ~ 45°C
NMP3 40K-24V-C90	DC 24V	2.6 W	179 lm	70lm/W	Ra>90	2,700K/3,000K/3,500K/4,000K	0 ~ 45°C
NMP4 40K-24V-C90	DC 24V	3.8 W	265 lm	69lm/W	Ra>90	2,700K/3,000K/3,500K/4,000K	0 ~ 45°C
NMP8 40K-24V-C90	DC 24V	7.7 W	540 lm	71lm/W	Ra>90	2,700K/3,000K/3,500K/4,000K	0 ~ 45°C

Dimension

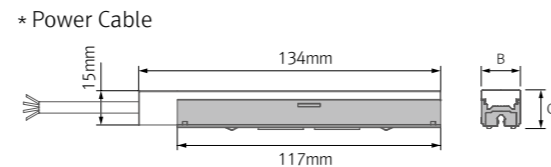
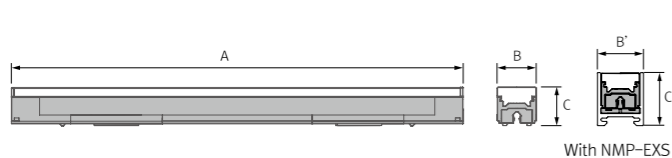
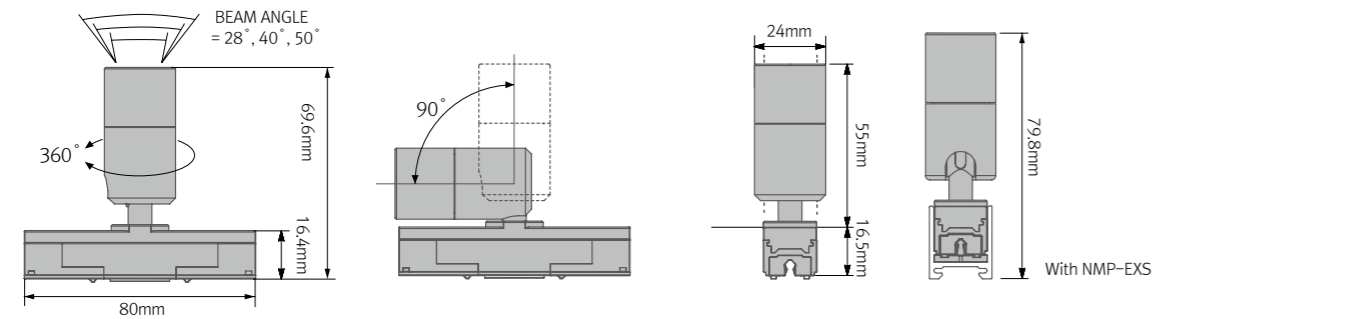

Model Name	Power Input (V)	Lamp Power (W)	A (mm)	B (mm)	B' (mm)	C (mm)	C' (mm)
NMP3 40K-24V-C90	DC 24	2.6W	97	18	21.4	16.5	24.7
NMP4 40K-24V-C90	DC 24	3.8W	145	18	21.4	16.5	24.7
NMP8 40K-24V-C90	DC 24	7.7W	288	18	21.4	16.5	24.7

Model Name	A (mm)	B (mm)	C (mm)
FLC30-24V/T	150	41	31
FLC75-24V-P/T	180	60	32

* LED Driver

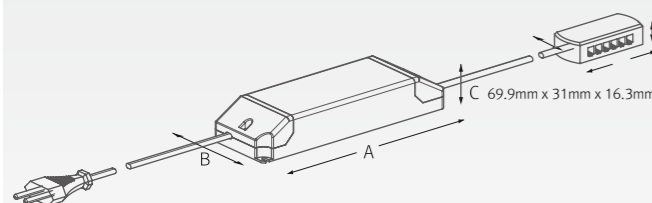

Model Name	A (mm)	B (mm)	C (mm)
FLC200-24V/T	228	68	39

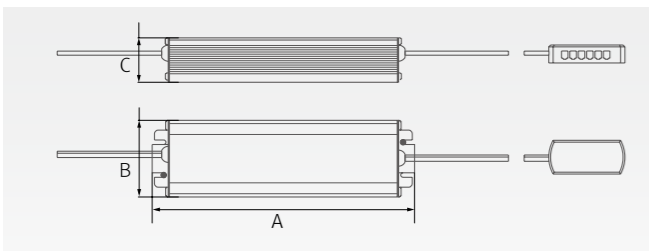

* Power Cable

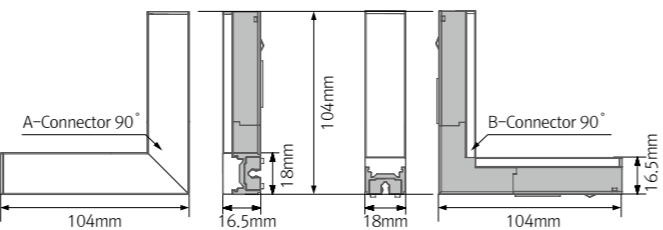
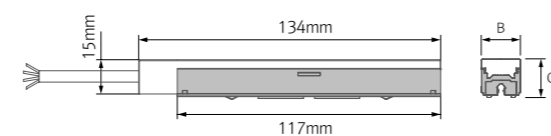

* Surface Extrusion

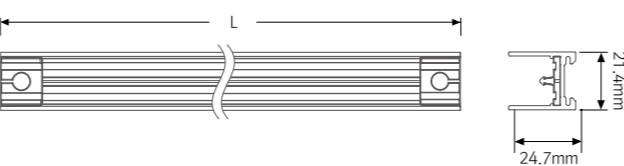

* Recessed Extrusion

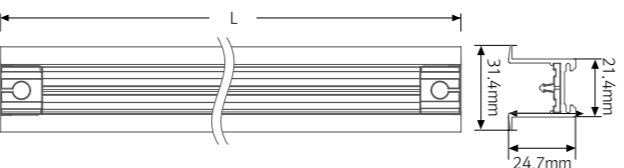

* Trimless Extrusion

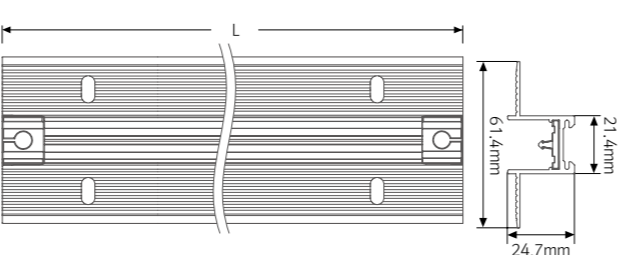

Accessories

Ⓐ MonoRail 2 Spot

Beam Angle	Black	White
28°	NMS3 40K-24V-C90-BK-28	NMS3 40K-24V-C90-WT-28
40°	NMS3 40K-24V-C90-BK-40	NMS3 40K-24V-C90-WT-40
50°	NMS3 40K-24V-C90-BK-50	NMS3 40K-24V-C90-WT-50

* Available Color : Black, White

Ⓑ MonoRail 2 Spot (Touch Sensor)

Beam Angle	Black	White
28°	NMS3 40K-24V-C90-BK-28-T	NMS3 40K-24V-C90-WT-28-T
40°	NMS3 40K-24V-C90-BK-40-T	NMS3 40K-24V-C90-WT-40-T
50°	NMS3 40K-24V-C90-BK-50-T	NMS3 40K-24V-C90-WT-50-T

* Available Color : Black, White

Ⓒ LED Power Connector : NMP3 40K-24V-C90-L134P-BK

MonoRail2 3W (134mm) DC24V LED Power Connector
* Available Color : Black, White

Ⓓ Power Connector : NMPPC-VE-BK

MonoRail2 Vertical Power Connection
* Available Color : Black, White

Ⓔ LED 90° Connector : NMP5 40K-24V-C90-90-BK

MonoRail2 90° Connector 5W
* Available Color : Black, White

⓫ 90° Connector : NMPCPL-90-BK

* Available Color : Black, White

⓬ LED Corner In Connector : NMP5 40K-24V-C90-CI-BK

MonoRail2 Corner in Connector 5W
* Available Color : Black, White

⓭ Corner In Connector : NMPCPL-CI-BK

* Available Color : Black, White

⓮ Direct Connector : NMPCPL-VE-BK

* Available Color : Black, White

⓯ Surface Track (600mm/1,200mm/2,400mm)

Black	White
NMP-EXS-BK	NMP-EXS-WT

⓰ Recessed Track (600mm/1,200mm/2,400mm)

Black	White
NMP-EXR-BK	NMP-EXR-WT

⓱ Trimless Track (600mm/1,200mm/2,400mm)

Black	White
NMP-EXT-BK	NMP-EXT-WT

⓲ Surface Track 90° Cap : NMP-EXS-90-CAP-BK

* Available Color : Black, White

⓳ Surface Track Corner In Cap : NMP-EXS-CI-CAP-BK

* Available Color : Black, White

⓴ Fixture Remover : NMP-REMOVER

⓵ Track Joint Bracket : NMP-JOINT BRACKET

⓶ Standard mounting bracket : NMP-BRACKET1

NMP-BRACKET1 : 1 set = 2 pcs

Accessories for MonoRail2 Pendant

⓷ Power Connector for Pendant : NMPPC-HE-BK

* Available Color : Black, White

⓸ Connecting Power Connector for Pendant : NMPPTC-HE-BK

* Available Color : Black, White

⓹ Direct for Pendant : NMPCPL-HE-BK

* Available Color : Black, White

⓺ L Connector for Pendant : NMPCPL-HE-L-BK

* Available Color : Black, White

⓻ LED Driver with 12way distributor, with power cord (1,800mm)

Part No	FLC30-24V/T	FLC75-24V-P/T
Capacity	30W 24V	75W 24V

⓼ LED Driver : FLC200-24V/T (200W, DC24V)

LED Driver With 12way distributor

