

FTM Track System

Super slim magnetic low voltage track system

- Ultra slim fixtures on easy magnetic rail system
- Adjustable beam angle by zoom function
- Available tilting up to 90°
- Safe with constant voltage DC 48V
- Various Track options (Surface, Trimless and Pendant mount track available)



FTM Track System - Spot



FTM-SS03

Photometric data

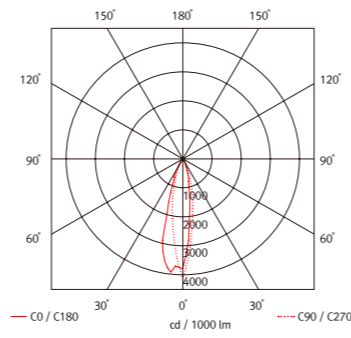

Specification

Model Name	Power Input	Lamp Power	Lumens (3,000K)	Efficiency (3,000K)	Color Rendering	Available color	Beam Angle	Weight of Luminaire	Operating Temperature
FTM-SS03 30K-48V	DC 48V	3 W	186.9 lm	63.36 lm/W	Ra > 90	2,700K/3,000K/3,500K/4,000K	15°/24°	41g	0 ~ 45°C

Dimension

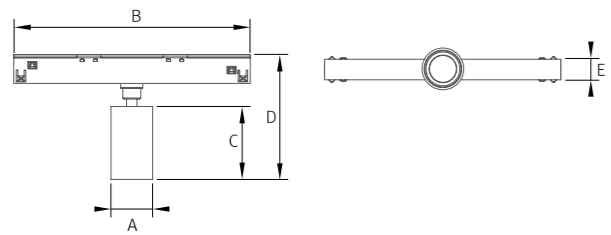

Model Name	A (mm)	B (mm)	C (mm)	D (mm)	E (mm)
FTM-SS03 30K-48V	20	142.5	35	63.3	10.7

Beam angle	Black	White
15°	FTM-SS03 30K-48V-BK-15	FTM-SS03 30K-48V-WT-15
24°	FTM-SS03 30K-48V-BK-24	FTM-SS03 30K-48V-WT-24



FTM-SS05

Photometric data

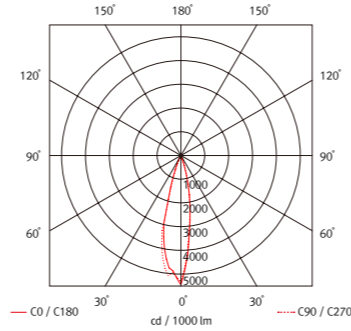

Specification

Model Name	Power Input	Lamp Power	Lumens (3,000K)	Efficiency (3,000K)	Color Rendering	Available color	Beam Angle	Weight of Luminaire	Operating Temperature
FTM-SS05 30K-48V	DC 48V	5 W	438.9 lm	76.07 lm/W	Ra > 90	2,700K/3,000K/3,500K/4,000K	15°/24°/36°	126g	0 ~ 45°C

Dimension

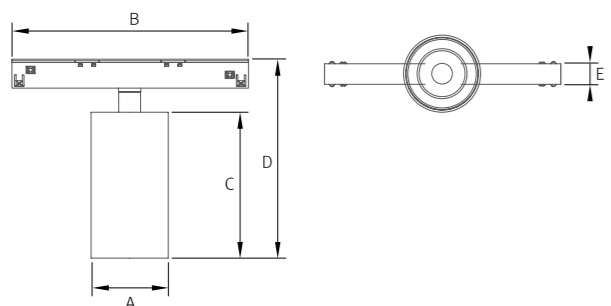

Model Name	A (mm)	B (mm)	C (mm)	D (mm)	E (mm)
FTM-SS05 30K-48V	35	142.5	70	99	10.7

Beam angle	Black	White
15°	FTM-SS05 30K-48V-BK-15	FTM-SS05 30K-48V-WT-15
24°	FTM-SS05 30K-48V-BK-24	FTM-SS05 30K-48V-WT-24
36°	FTM-SS05 30K-48V-BK-36	FTM-SS05 30K-48V-WT-36



FTM-SS05 zoom

Photometric data

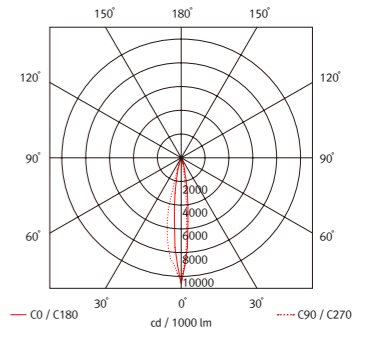

Specification

Model Name	Power Input	Lamp Power	Lumens (3,000K)	Efficiency (3,000K)	Color Rendering	Available color	Beam Angle	Weight of Luminaire	Operating Temperature
FTM-SS05 30K-48V-ZOOM	DC 48V	5 W	280.7 lm	56.54 lm/W	Ra > 90	2,700K/3,000K/3,500K/4,000K	15°~40°	126g	0 ~ 45°C

Dimension

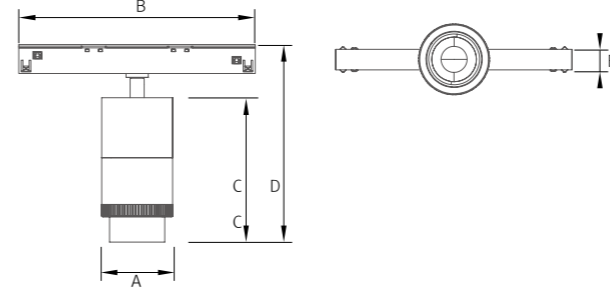

Model Name	A (mm)	B (mm)	C (mm)	D (mm)	E (mm)
FTM-SS05 30K-48V-ZOOM	34	142.5	69.2	98.3	10.7

Beam angle	Black	White
15°~40°	FTM-SS05 30K-48V-ZOOM-BK-15*40	FTM-SS05 30K-48V-ZOOM-WT-15*40



FTM-SS10

Photometric data

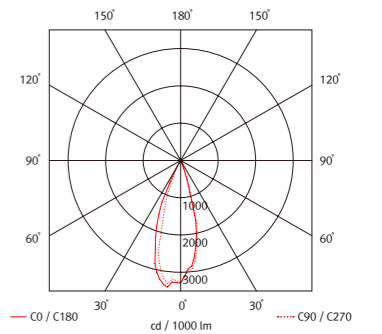

Specification

Model Name	Power Input	Lamp Power	Lumens (3,000K)	Efficiency (3,000K)	Color Rendering	Available color	Beam Angle	Weight of Luminaire	Operating Temperature
FTM-SS10 30K-48V	DC 48V	10 W	744.6 lm	76.34 lm/W	Ra > 90	2,700K/3,000K/3,500K/4,000K	15°/24°/36°	171g	0 ~ 45°C

Dimension

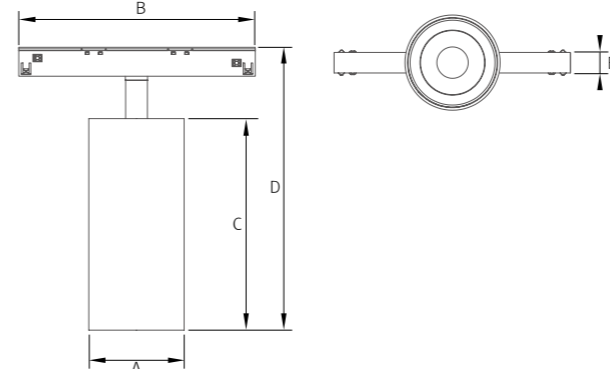

Model Name	A (mm)	B (mm)	C (mm)	D (mm)	E (mm)
FTM-SS10 30K-48V	46	142.5	102	144.5	10.7

Beam angle	Black	White
15°	FTM-SS10 30K-48V-BK-15	FTM-SS10 30K-48V-WT-15
24°	FTM-SS10 30K-48V-BK-24	FTM-SS10 30K-48V-WT-24
36°	FTM-SS10 30K-48V-BK-36	FTM-SS10 30K-48V-WT-36



FTM-SS15

Photometric data

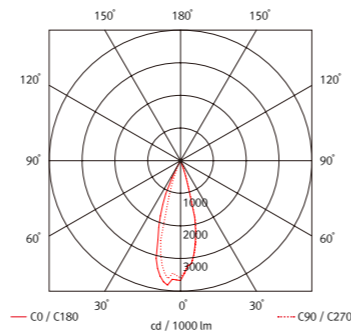

Specification

Model Name	Power Input	Lamp Power	Lumens (3,000K)	Efficiency (3,000K)	Color Rendering	Available color	Beam Angle	Weight of Luminaire	Operating Temperature
FTM-SS15 30K-48V	DC 48V	15 W	1,186.3 lm	79.08 lm/W	Ra > 90	2,700K/3,000K/3,500K/4,000K	15° / 24° / 36°	245g	0 ~ 45°C

Dimension

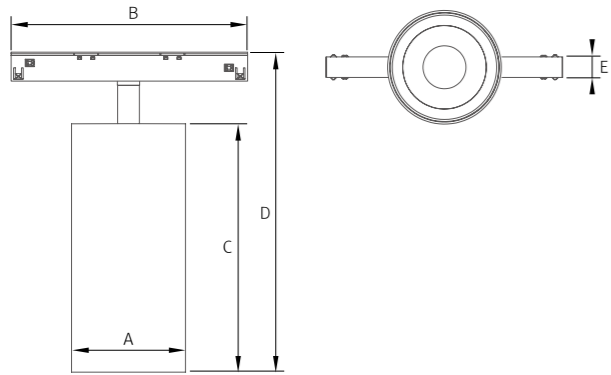

Model Name	A (mm)	B (mm)	C (mm)	D (mm)	E (mm)
FTM-SS15 30K-48V	55	142.5	120	162.5	10.7

Beam angle	Black	White
15°	FTM-SS15 30K-48V-BK-15	FTM-SS15 30K-48V-WT-15
24°	FTM-SS15 30K-48V-BK-24	FTM-SS15 30K-48V-WT-24
36°	FTM-SS15 30K-48V-BK-36	FTM-SS15 30K-48V-WT-36



FTM-SS15-ZOOM

Photometric data

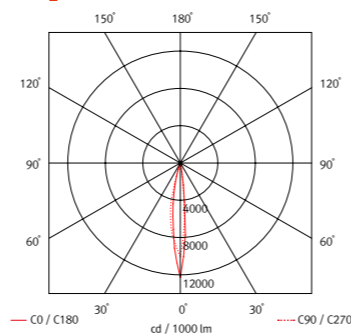

Specification

Model Name	Power Input	Lamp Power	Lumens (3,000K)	Efficiency (3,000K)	Color Rendering	Available color	Beam Angle	Weight of Luminaire	Operating Temperature
FTM-SS15-30K-48V-ZOOM	DC 48V	15 W	1,055.4 lm	73.95 lm/W	Ra > 90	2,700K/3,000K/3,500K/4,000K	20° ~ 55°	269g	0 ~ 45°C

Dimension

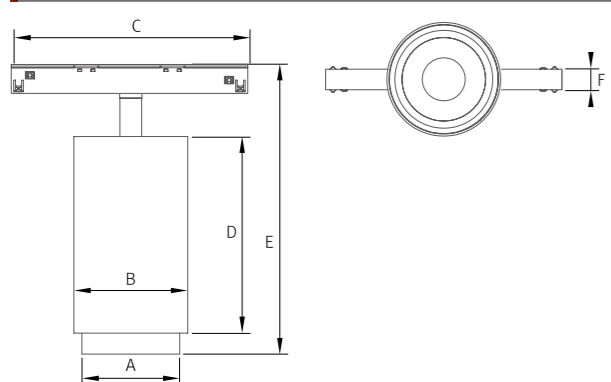

Model Name	A (mm)	B (mm)	C (mm)	D (mm)	E (mm)	F (mm)
FTM-SS15 30K-48V-ZOOM	47.3	55	142.5	95	140.3	10.7

Beam angle	Black	White
20 ~ 55°	FTM-SS15 30K-48V-ZOOM-BK-20*55	FTM-SS15 30K-48V-ZOOM-WT-20*55

FTM Track System - Stix



FTM-LS20

Photometric data

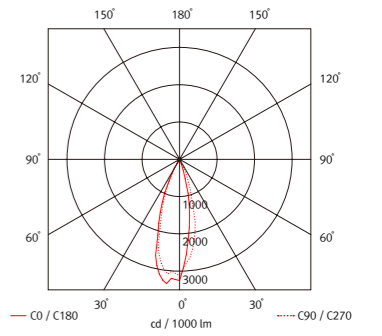

Specification

Model Name	Power Input	Lamp Power	Lumens (3,000K)	Efficiency (3,000K)	Color Rendering	Available color	Beam Angle	Weight of Luminaire	Operating Temperature
FTM-LS20 30K-48V	DC 48V	10 W	587.5 lm	62.52 lm/W	Ra > 90	2,700K/3,000K/3,500K/4,000K	30°	78g	0 ~ 45°C

Dimension

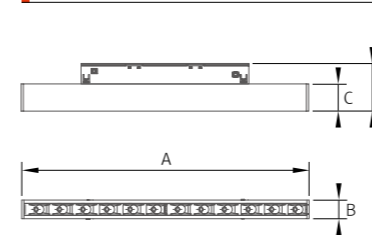

Model Name	A (mm)	B (mm)	C (mm)	D (mm)
FTM-LS20 30K-48V	195	12.7	18.5	36

Beam angle	Black	White
30°	FTM-LS20 30K-48V-BK-30	FTM-LS20 30K-48V-WT-30



FTM-LS20-TILT

Photometric data

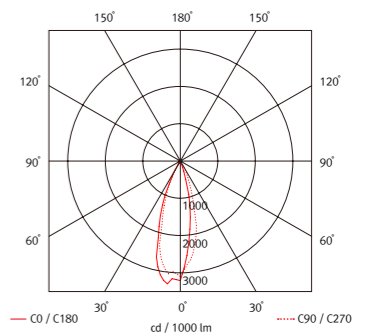

Specification

Model Name	Power Input	Lamp Power	Lumens (3,000K)	Efficiency (3,000K)	Color Rendering	Available color	Beam Angle	Weight of Luminaire	Operating Temperature
FTM-LS20 30K-48V-TILT	DC 48V	10 W	602.3 lm	63.80 lm/W	Ra > 90	2,700K/3,000K/3,500K/4,000K	30°	197g	0 ~ 45°C

Dimension

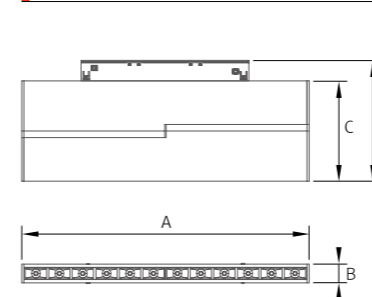

Model Name	A (mm)	B (mm)	C (mm)	D (mm)
FTM-LS20 30K-48V-TILT	195	12.7	68	85.5

Beam angle	Black	White
30°	FTM-LS20 30K-48V-TILT-BK-30	FTM-LS20 30K-48V-TILT-WT-30



FTM-LS30

Photometric data

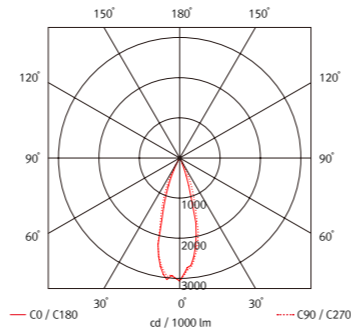

Specification

Model Name	Power Input	Lamp Power	Lumens (3,000K)	Efficiency (3,000K)	Color Rendering	Available color	Beam Angle	Weight of Luminaire	Operating Temperature
FTM-LS30 30K-48V	DC 48V	15 W	839.4 lm	64.05 lm/W	Ra > 90	2,700K/3,000K/3,500K/4,000K	30°	107g	0 ~ 45°C

Dimension

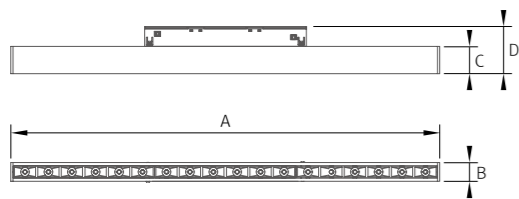

Model Name	A (mm)	B (mm)	C (mm)	D (mm)
FTM-LS30 30K-48V	291	12.7	18.5	35.8

Beam angle	Black	White
30°	FTM-LS30 30K-48V-BK-30	FTM-LS30 30K-48V-WT-30



FTM-LM20

Photometric data

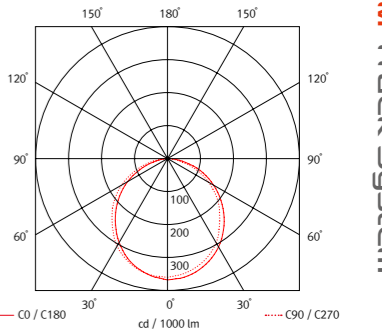

Specification

Model Name	Power Input	Lamp Power	Lumens (3,000K)	Efficiency (3,000K)	Color Rendering	Available color	Beam Angle	Weight of Luminaire	Operating Temperature
FTM-LM20 30K-48V	DC 48V	10 W	475.4 lm	47.91 lm/W	Ra > 90	2,700K/3,000K/3,500K/4,000K	110°	72g	0 ~ 45°C

Dimension

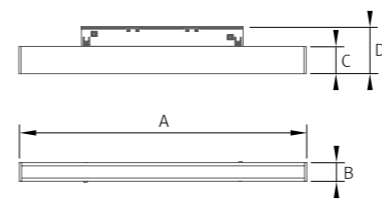

Model Name	A (mm)	B (mm)	C (mm)	D (mm)
FTM-LM20 30K-48V	195	12.7	18.5	36

Beam angle	Black	White
110°	FTM-LM20 30K-48V-BK-110	FTM-LM20 30K-48V-WT-110



FTM-LS30-TILT

Photometric data

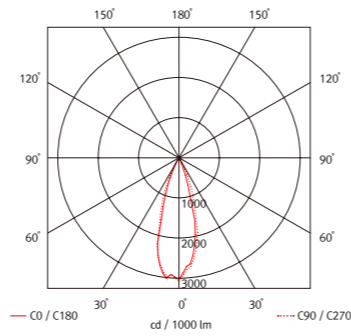

Specification

Model Name	Power Input	Lamp Power	Lumens (3,000K)	Efficiency (3,000K)	Color Rendering	Available color	Beam Angle	Weight of Luminaire	Operating Temperature
FTM-LS30 30K-48V-TILT	DC 48V	15 W	827.9 lm	64.21 lm/W	Ra > 90	2,700K/3,000K/3,500K/4,000K	30°	276g	0 ~ 45°C

Dimension

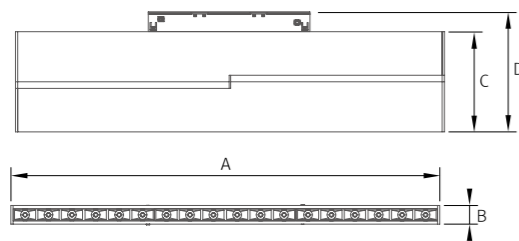

Model Name	A (mm)	B (mm)	C (mm)	D (mm)
FTM-LS30 30K-48V-TILT	291	12.7	68	85.5

Beam angle	Black	White
30°	FTM-LS30 30K-48V-TILT-BK-30	FTM-LS30 30K-48V-TILT-WT-30



FTM-LM20-TILT

Photometric data

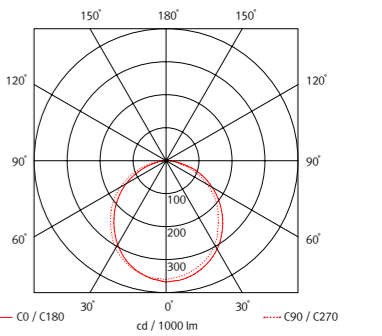

Specification

Model Name	Power Input	Lamp Power	Lumens (3,000K)	Efficiency (3,000K)	Color Rendering	Available color	Beam Angle	Weight of Luminaire	Operating Temperature
FTM-LM20 30K-48-TILT	DC 48V	10 W	455.1 lm	45.17 lm/W	Ra > 90	2,700K/3,000K/3,500K/4,000K	110°	192g	0 ~ 45°C

Dimension

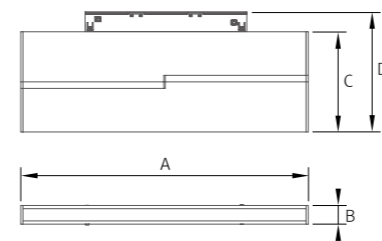

Model Name	A (mm)	B (mm)	C (mm)	D (mm)
FTM-LM20 30K-48V-TILT	195	12.7	68	85.5

Beam angle	Black	White
110°	FTM-LM20 30K-48V-TILT-BK-110	FTM-LM20 30K-48V-TILT-WT-110



FTM-LM30

Photometric data

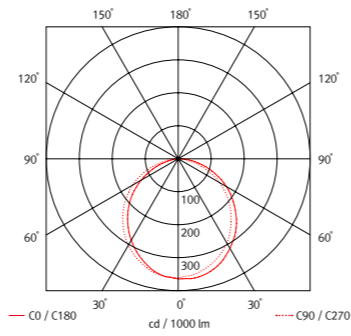

Specification

Model Name	Power Input	Lamp Power	Lumens (3,000K)	Efficiency (3,000K)	Color Rendering	Available color	Beam Angle	Weight of Luminaire	Operating Temperature
FTM-LM30 30K-48V	DC 48V	15 W	724.5 lm	52.42 lm/W	Ra > 90	2,700K/3,000K/3,500K/4,000K	110°	98g	0 ~ 45°C

Dimension

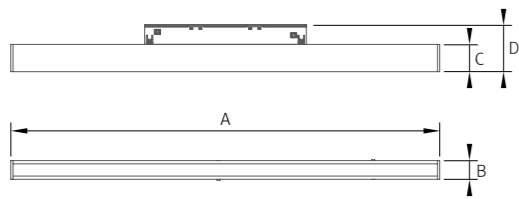

Model Name	A (mm)	B (mm)	C (mm)	D (mm)
FTM-LM30 30K-48V	291	12.7	18.5	36

Beam angle	Black	White
110°	FTM-LM30 30K-48V-BK-110	FTM-LM30 30K-48V-WT-110



FTM-LM30-TILT

Photometric data

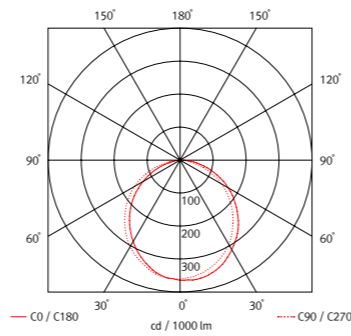

Specification

Model Name	Power Input	Lamp Power	Lumens (3,000K)	Efficiency (3,000K)	Color Rendering	Available color	Beam Angle	Weight of Luminaire	Operating Temperature
FTM-LM30 30K-48V-TILT	DC 48V	15 W	710.5 lm	53.38 lm/W	Ra > 90	2,700K/3,000K/3,500K/4,000K	110°	269g	0 ~ 45°C

Dimension

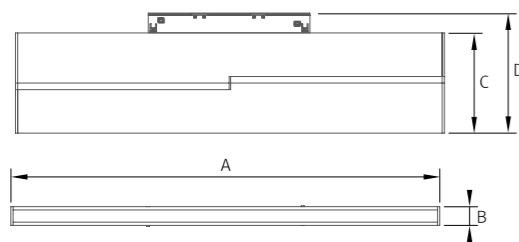

Model Name	A (mm)	B (mm)	C (mm)	D (mm)
FTM-LM30 30K-48V-TILT	291	12.7	68	85.5

Beam angle	Black	White
110°	FTM-LM30 30K-48V-TILT-BK-110	FTM-LM30 30K-48V-TILT-WT-110

FTM Track



Surface

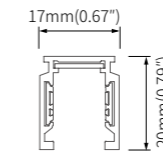

Pendant

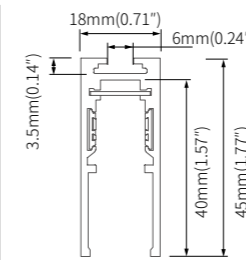

Pendant

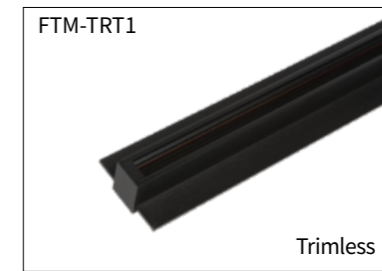
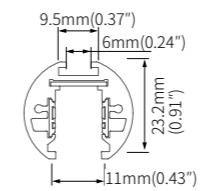

Trimless

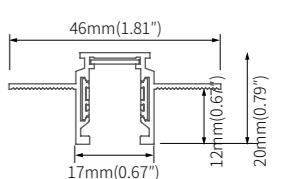

Trimless

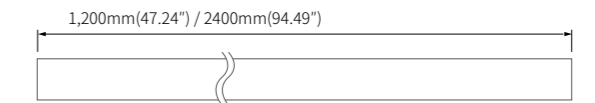
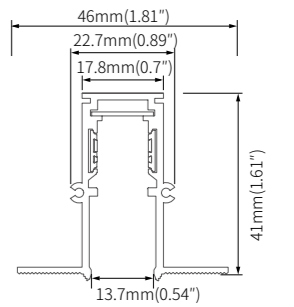

Luminaire	Compatible Luminaires				
	FTM-TRS1	FTM-TRS2	FTM-TRT1	FTM-TRT2	FTM-TRP
FTM-SS03	○		○		○
FTM-SS05	○		○		○
FTM-SS05-ZOOM	○		○		○
FTM-SS10	○	○	○	○	○
FTM-SS15	○	○	○	○	○
FTM-SS15-ZOOM	○	○	○	○	○
FTM LS20	○	○	○	○	○
FTM LS20-TILT	○	○	○	○	○
FTM LS30	○	○	○	○	○
FTM LS30-TILT	○	○	○	○	○
FTM LM20	○	○	○	○	○
FTM LM20-TILT	○	○	○	○	○
FTM LM30	○	○	○	○	○
FTM LM30-TILT	○	○	○	○	○

* SS03 / SS05 / SS05-Zoom are not compatible with TRS2, TRT2 track.

Installation

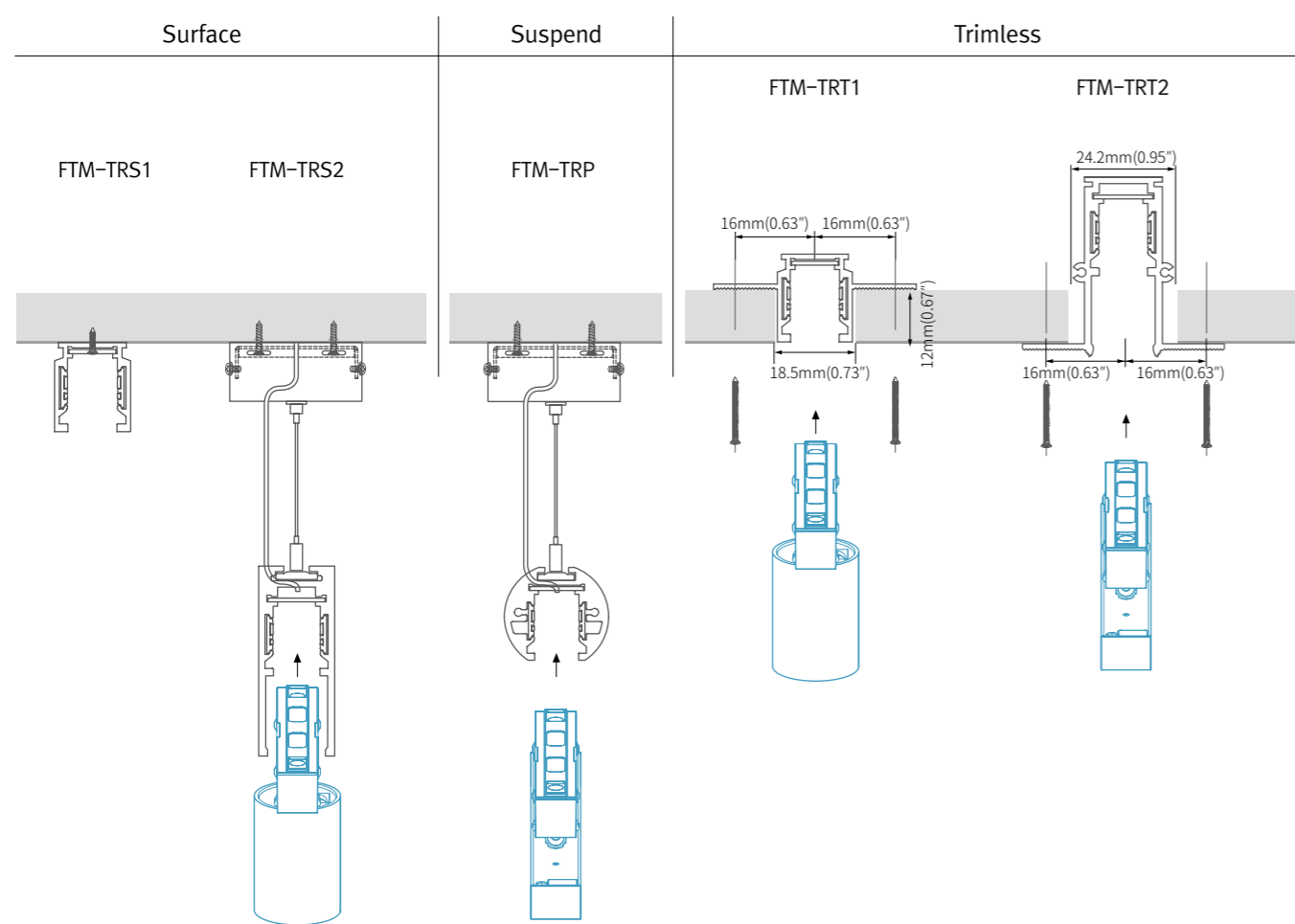

Accessories

- a) FTMOPC**
Power Connector for FTM
- b) FTMPTC**
Flexible Connector
- c) FTMCPPL**
Direct Connector
- d) FTM-JOINT 1**
Joint Bracket for TRS1, TRT1, TRP
- e) FTM-JOINT 2**
Joint Bracket for TRS2, TRT2
- f) FTM-SK-POWER**
Suspension Power Kit
- g) LED Driver : FLC200-48V/T (200W DC48V)**
LED Driver : FLC100-48V/T(100W DC48V)
LED Driver With 12way distributor
- h) Dimming Interface : FDD-L20 (0-10/1-10V)**
Max. 400W (200W/CH, 2CH)

