







# FLX Stix CDV

Ultra Slim Refrigeration lighting

*High Efficiency. IP65 Rating.  
Super slim Freezer and Cooler lighting.  
Special Beam Angle for Multiple Uses.*



- Freezer equipment 
- Multiple Uses 
- High Efficiency (115mw) 
- Asymmetric Lens 

# FLX Stix CDV

Ultra Slim Refrigeration lighting

- Super slim Freezer and Cooler lighting
- High Efficiency(115lm/w)
- High CRI(Ra>90)
- IP65 Rating
- Operating Temperature : -35 °C ~ 35 °C
- Comply with EN 60335-2-89

Model	CDV4	CDV8	CDV12	CDV16	CDV20
Power Input	DC 24V				
Lamp Power	4 W	8.3 W	12.3 W	16.5 W	20.6 W
Lumens	460 lm	955 lm	1,415 lm	1,898 lm	2,369 lm
Efficiency	115 lm/w				
Color Rendering	Ra > 90				
Available Color	3,000 K / 4,000 K / MEAT RED				
Operating Temperature	-30 ~ 35 °C				
IP	IP 65				
Lamp Life	50,000hrs L70				

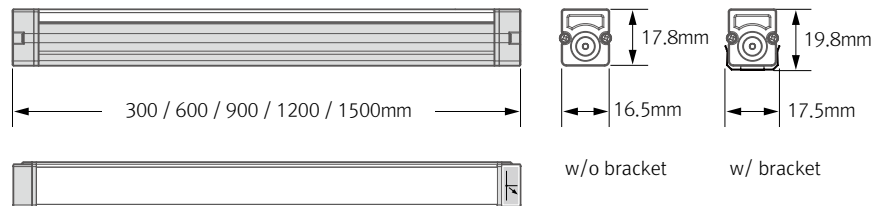

Asymmetric frosted

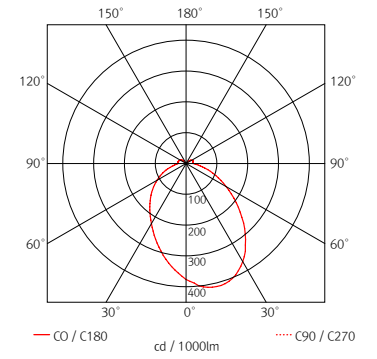
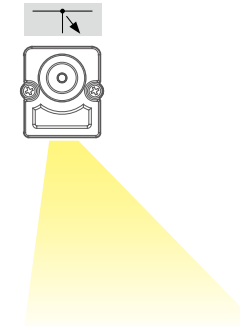

CDV's Asymmetric Light Distribution provides Improved visibility and presentation of the products on display



Ultra Slim Refrigeration lighting

## MULTIPLE USES



CDV can create center or side lit by connection of two modules.

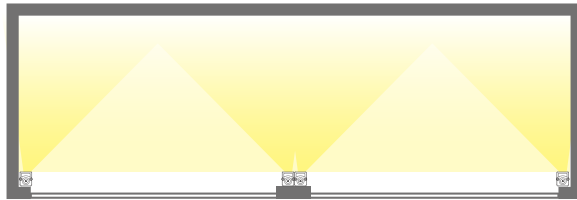

## APPLICATION

Door type

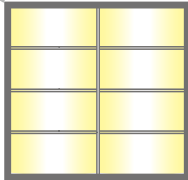

Canopy type

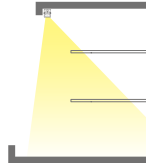

Handrail type



Counter type

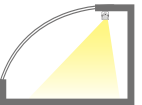

## EASY CONNECTION

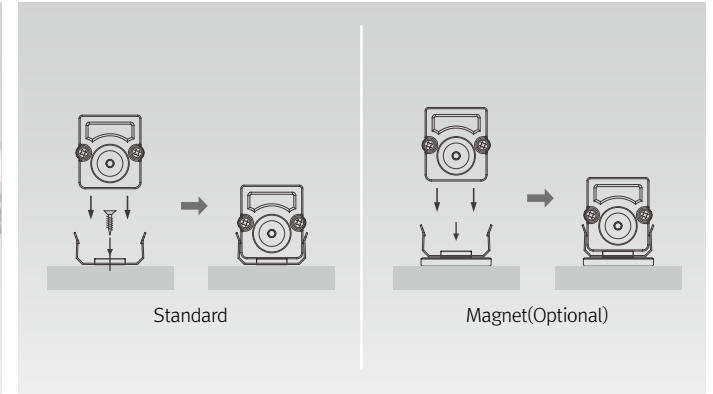
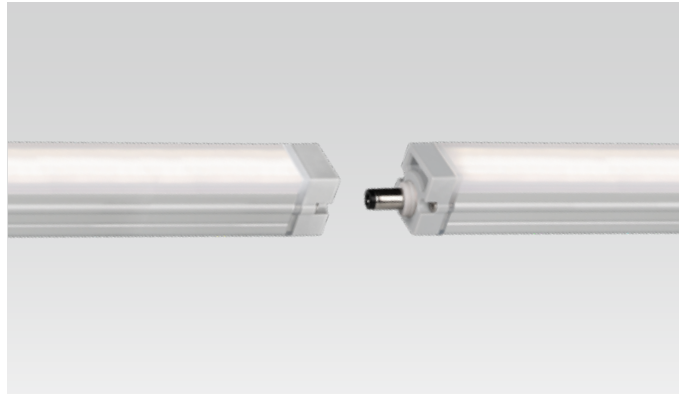
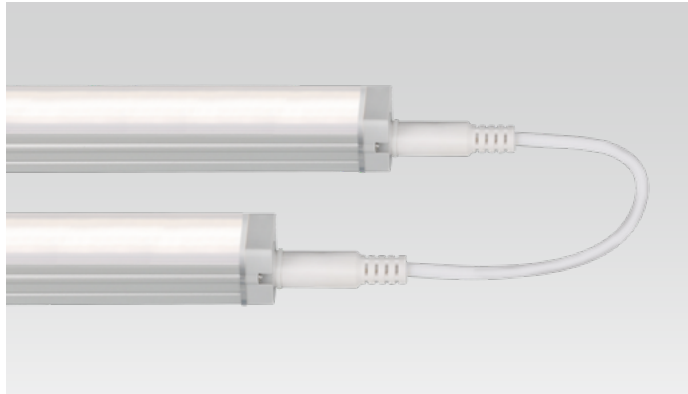

Connecting Cable \_\_ CDVPTC  
150mm

Direct connector \_\_ CDVCPL

Standard

Magnet(Optional)

Power Cable \_\_ CDVPC  
1,800mm

LED Driver \_\_ FLC200-24V/T (200W)  
IP 67 rating

LED Driver \_\_ FLC75-24V/T (75W)

Model	CDV4-40K-24V	CDV8-40K-24V	CDV12-40K-24V	CDV16-40K-24V	CDV20-40K-24V
Length (mm)	300	600	900	1200	1500
Max.Linkable (PCS)	10	6	4	3	2
Max. Length Available	3700 mm				