

**FLX Stix NDV***LED for Display, Cabinet, Furniture & Cove*

Little light, Big punch!!

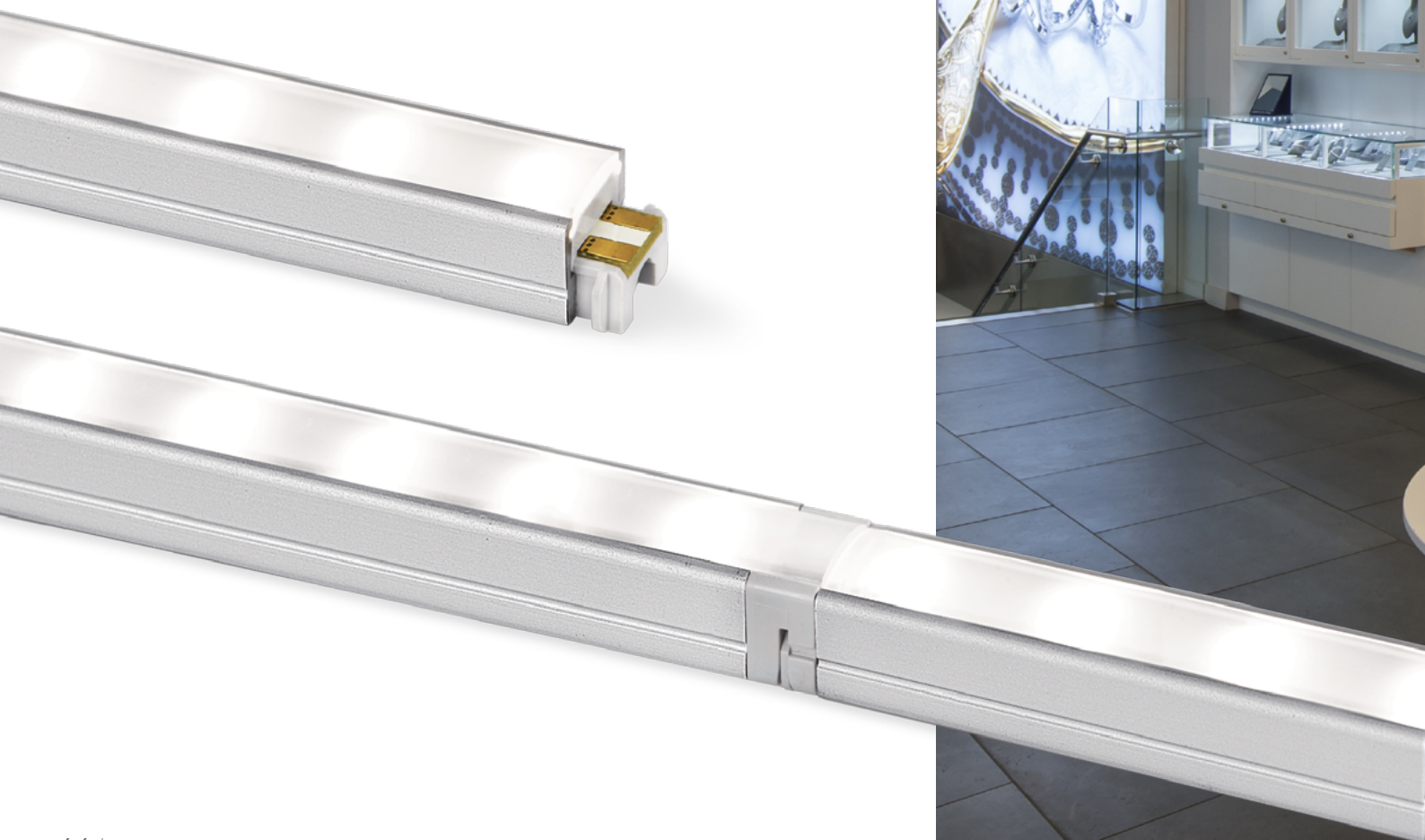

- Super Slim linear LED with standard output
- Quick connection system between fixtures
- Many lengths available
- Various mounting methods including magnetic
- To be used with constant voltage DC 24V driver
- Dimmable with available accessories







**FLX Stix NDV**  
Standard Output



FLX Stix NDV 1W length (100 mm)



FLX Stix NDV 3W length (192 mm)



FLX Stix NDV 4W length (285 mm)



FLX Stix NDV 7W length (565 mm)



FLX Stix NDV 11W length (845 mm)



FLX Stix NDV 15W length (1123mm)

**Various options**

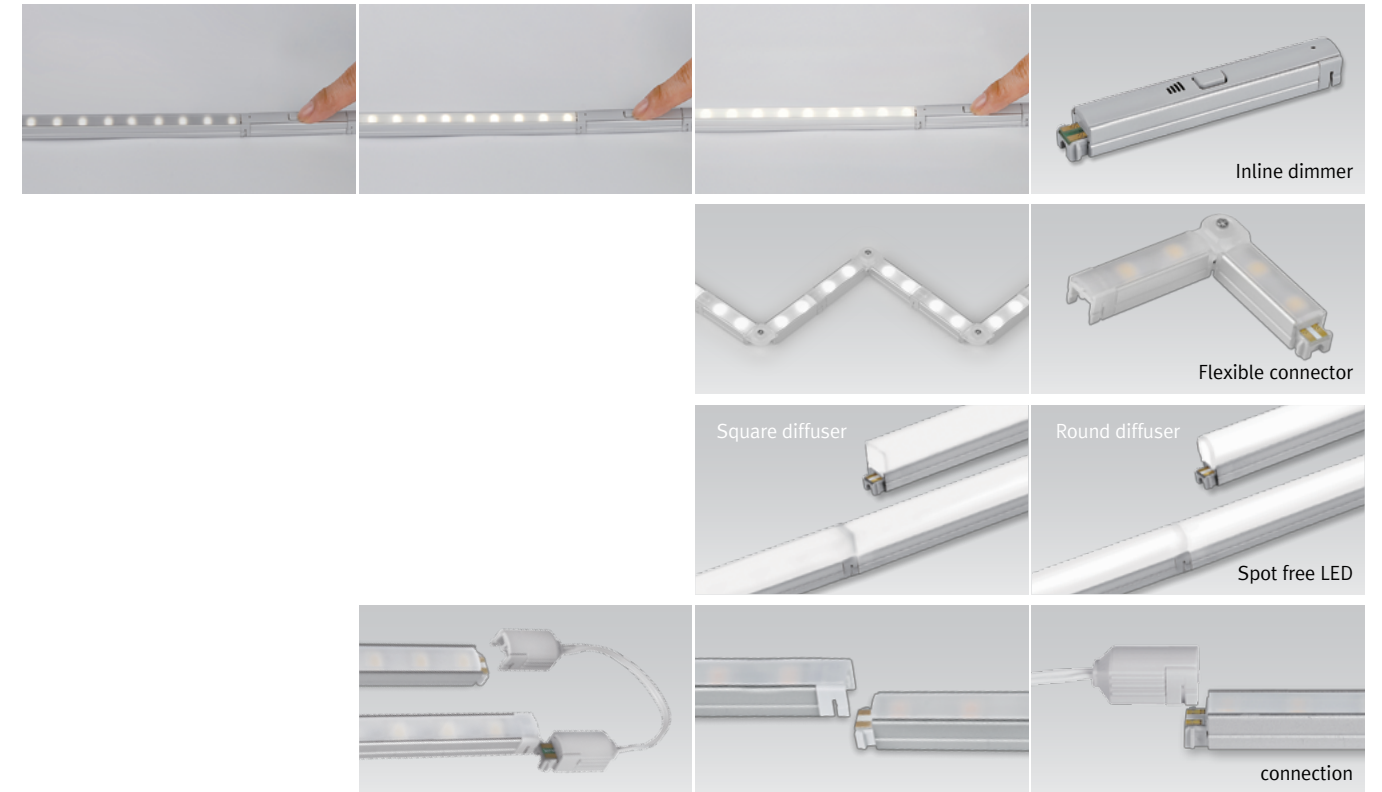

**Installation**

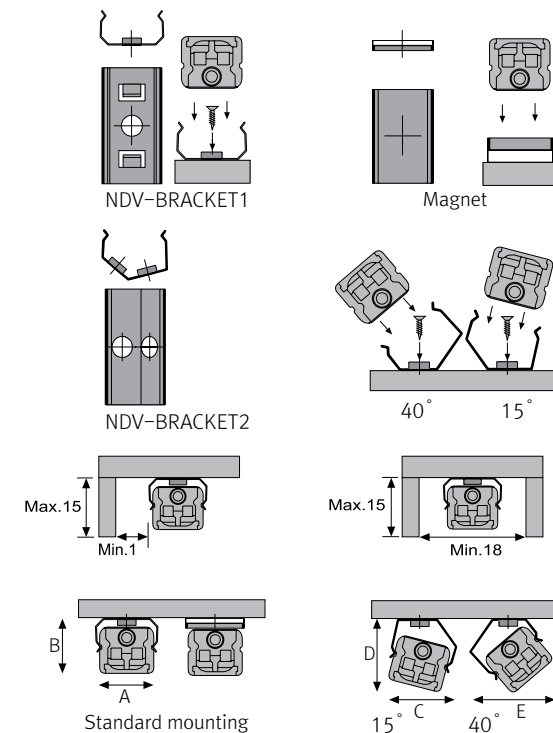

**Max. connection**

- FLX Stix NDV : 55W in one row(single power feed)
- LED Driver

Model Name	Max. units for LED Driver			
	24V/15W	24V/30W	24V/75W	24V/200W
NDV1 40K-24V	12	25	62	160
NDV3 40K-24V	5	10	25	66
NDV4 40K-24V	4	7	18	50
NDV7 40K-24V	2	4	10	28
NDV11 40K-24V	1	2	6	18
NDV14 40K-24V	1	2	5	13

- W/ Bracket

	A(mm)	B(mm)	C(mm)	D(mm)	E(mm)	F(mm)
Flat type	11.9	11.2	13.5	13.5	14.5	13
Round type	11.9	19.8	15.7	15.7	18.8	20.3
Square type	11.9	19.6	15.5	15.8	18.8	20.3

**Specification**

Model Name	Power Input	Lamp Power	Luminous Flux	Efficiency	Color Rendering	Available Color	Operating Temperature
NDV1 40K-24V	DC24V	1W	75 lm	75 lm/W	Ra > 85	2,700K/3,000K/3,500K/4,000K/6,000K	0-45°C
NDV3 40K-24V	DC24V	3W	225 lm	75 lm/W	Ra > 85	2,700K/3,000K/3,500K/4,000K/6,000K	0-45°C
NDV4 40K-24V	DC24V	4W	300lm	75 lm/W	Ra > 85	2,700K/3,000K/3,500K/4,000K/6,000K	0-45°C
NDV7 40K-24V	DC24V	7W	525lm	75 lm/W	Ra > 85	2,700K/3,000K/3,500K/4,000K/6,000K	0-45°C
NDV11 40K-24V	DC24V	11W	825lm	75 lm/W	Ra > 85	2,700K/3,000K/3,500K/4,000K/6,000K	0-45°C
NDV15 40K-24V	DC24V	15W	1,125lm	75 lm/W	Ra > 85	2,700K/3,000K/3,500K/4,000K/6,000K	0-45°C

**Dimension**

Model Name	Power Input (V)	Lamp Power (W)	A (mm)	B (mm)	C (mm)	D (mm)	E (mm)	F (mm)	G (mm)
NDV1 40K-24V	DC 24	1	95	100	117	12	11	10.6	9
NDV3 40K-24V	DC24	3	188	192	210	12	11	10.6	9
NDV4 40K-24V	DC 24	4	280	285	302	12	11	10.6	9
NDV7 40K-24V	DC 24	7	560	565	582	12	11	10.6	9
NDV11 40K-24V	DC 24	11	840	845	862	12	11	10.6	9
NDV15 40K-24V	DC 24	14	1,118	1,123	1,140	12	11	10.6	9

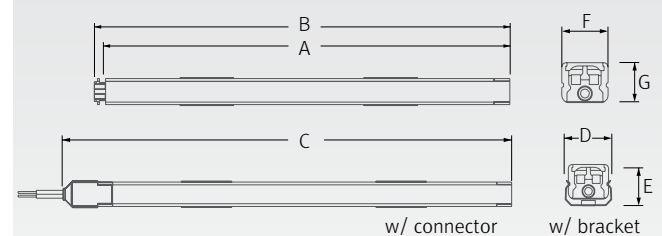

Model Name	A (mm)	B (mm)	C (mm)
FLC15-24V/T	121	45	16
FLC30-24V/T	150	41	31
FLC75-24V/T	180	60	32

**\* LED Converter**

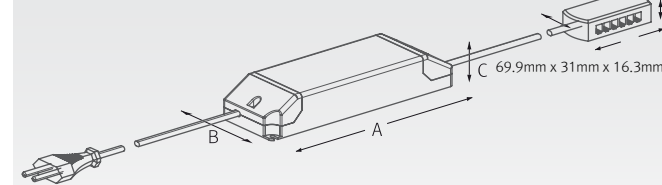

Model Name	A (mm)	B (mm)	C (mm)
FLC200-24V/T	228	68	39

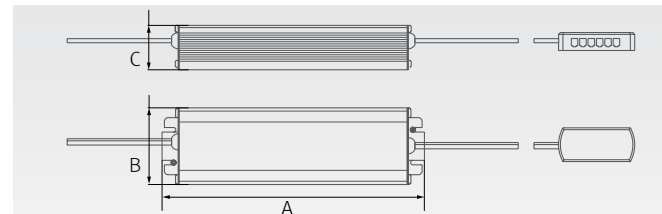

**Accessories**

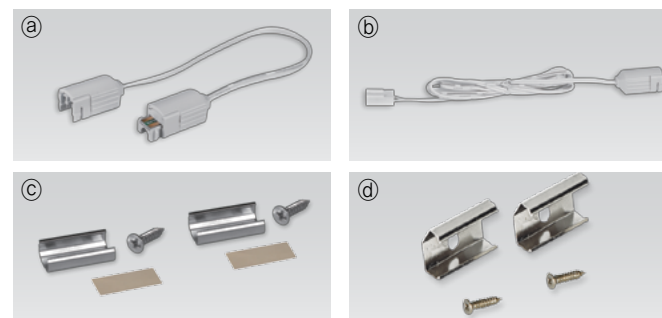

**\* Round diffuser**

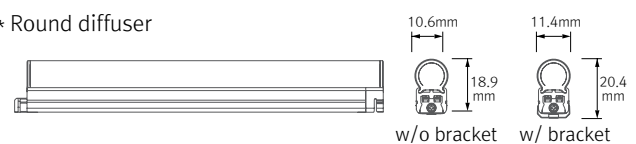

**\* Square diffuser**

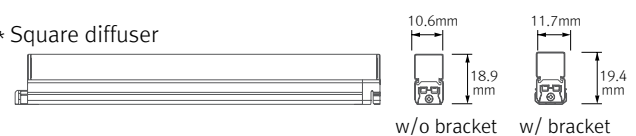

**\* Inline dimmer**

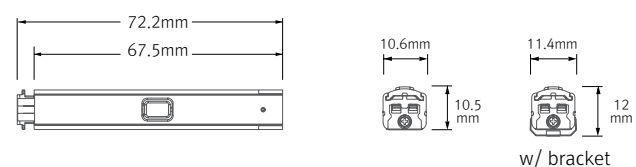

**\* Flexible connector**

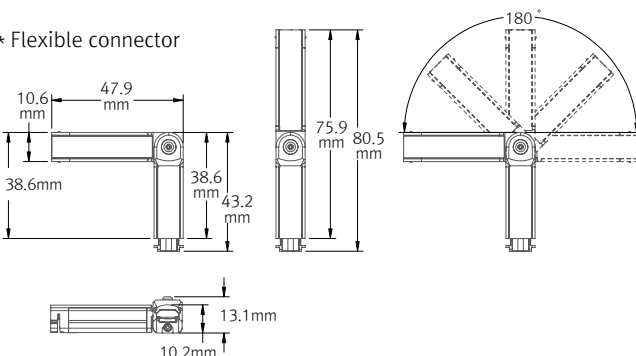

**ⓐ Connecting cables(between FLX Stix NDV & FLX Stix NDV)**

NDVPTC	NDVPTC1	NDVPTC2	NDVPTC4	NDVPTC6
150mm(6inch)	300mm(1feet)	600mm(2feet)	1200mm(4feet)	1800mm(6feet)

**ⓑ Power cable : NDVPC**

Power cable (Between DIVA2 & 6-way distributor)

**ⓒ Mounting bracket : NDV-BRACKET 1**

Included in fixture  
 NDV-BRACKET1(A) : 1set = 2pcs  
 NDV-BRACKET1(B) : 1set = 3pcs

**ⓓ Angle bracket (15° & 40°) : NDV-BRACKET 2**

NDV-BRACKET2(A) : 1set = 2pcs  
 NDV-BRACKET2(B) : 1set = 3pcs

**ⓔ Sidefeed for seamless extension (3W) : NDV3 40K-24V-S**

The dimension is the same as NDV3 40K-24V  
 Powered only through cable, no power supply on the input connector



**ⓕ Connector : NDV1 40K-24V-FLEX**

FLX Stix NDV Flexible connector(1W)

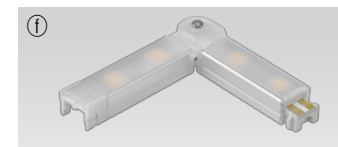

**ⓖ End cap : NDV-CAP**

Included in fixture

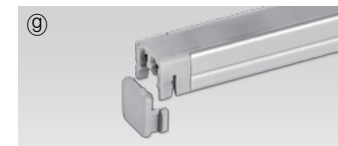

**ⓗ LED Driver with 12way distributor, with power cord (1800mm)**

Part No	FLC15-24V/T	FLC30-24V/T	FLC75-24V/T
Capacity	15W 24V	30W 24V	75W 24V



**Ⓢ LED Driver : FLC200-24V/T (200W 24V)**

LED Driver With 12way distributor



**Ⓣ Dimming Interface(0-10/1-10,DMX512)**

FDA-L2M0 : Max. 200W (100W/CH, 2CH)  
 FDA-L5M : Max. 200W (100W/CH, 5CH)



**Ⓚ Inline dimmer : NDVDIM**

Max 55W in a row



**Ⓛ Round diffuser**

NDV1CVRM	NDV3CVRM	NDV4CVRM	NDV7CVRM	NDV11CVRM	NDV15CVRM
1W	3W	4W	7W	11W	15W

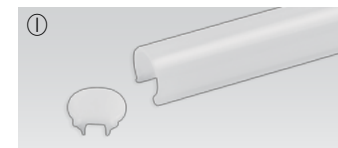

**Ⓜ Square diffuser**

NDV1CVSM	NDV3CVSM	NDV4CVSM	NDV7CVSM	NDV11CVSM	NDV15CVSM
1W	3W	4W	7W	11W	15W

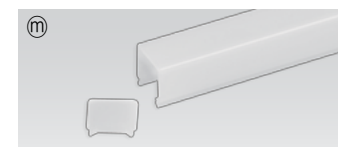

**Ⓨ Door and motion detection sensor : FLS-M24V**

Voltage : DC 24V



**Ⓩ Human-body detection sensor : FLS-P24V**

Voltage : DC 24V



**ⓐ Connecting bracket : NDV-BRACKET3**

Included in fixture



**ⓑ Power bracket : NDV-BRACKET4**

Provided with Power cable (NDVPC)

