

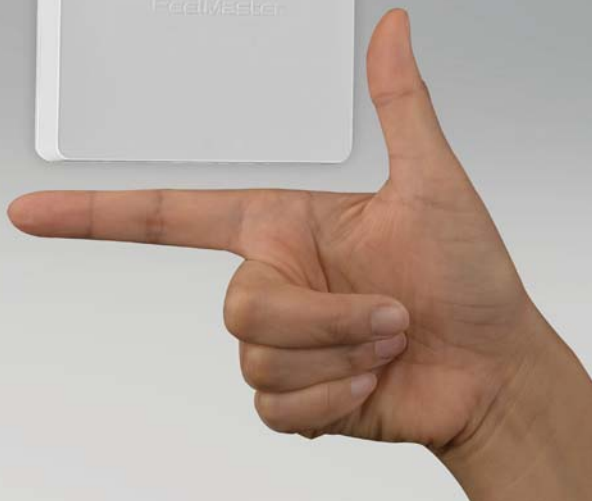

Feelmaster

Feelux remote control system





Feelmaster

Master Control your environment with Feelmaster !

White



Black



Feelmaster

Application for various place

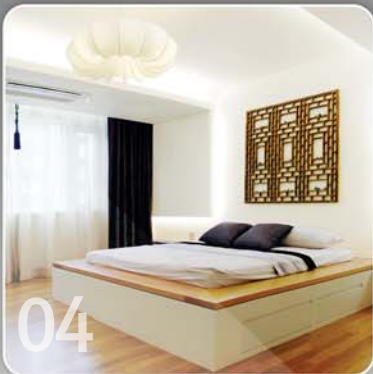

- 01 Museum
- 02 Hotel / Resort
- 03 Shop / Store / Department
- 04 Home
- 05 Office



Smart phone, Tablet, Wall mounted switch

What is Feelmaster ?

Feelmaster is feelux's all in one remote control system. Feelmaster lets you control lighting, sound, video, control, and temperature with touch of your fingertip. Simply begin by connecting to your local network, and application will automatically detect Feelmaster. Then, control your place, the way you want it.

Feelmaster Features

- Plug-and-Play remote control system
- Intergrated control system
- Compatible with IOS and Android smart phones or tablets
- Support Wire and Wireless. (RS485, WAN, LAN, Wi-Fi, zigbee)
- Natural Light Care / Natural Ventilation / Energy Saving Optimization

Feelmaster

Simple & Easy integrated control system

Create your own Pleasant Environment



Feelmaster

How to operate Feelmaster

Step 1.

Plug in feelmaster and decoder to its power source accordingly.



Step 2.

Search Feelmaster signal on the wifi list and run Feelmaster application.



Step 3.

Enter serial number on the decoder for pairing between Feelmaster and decoder.

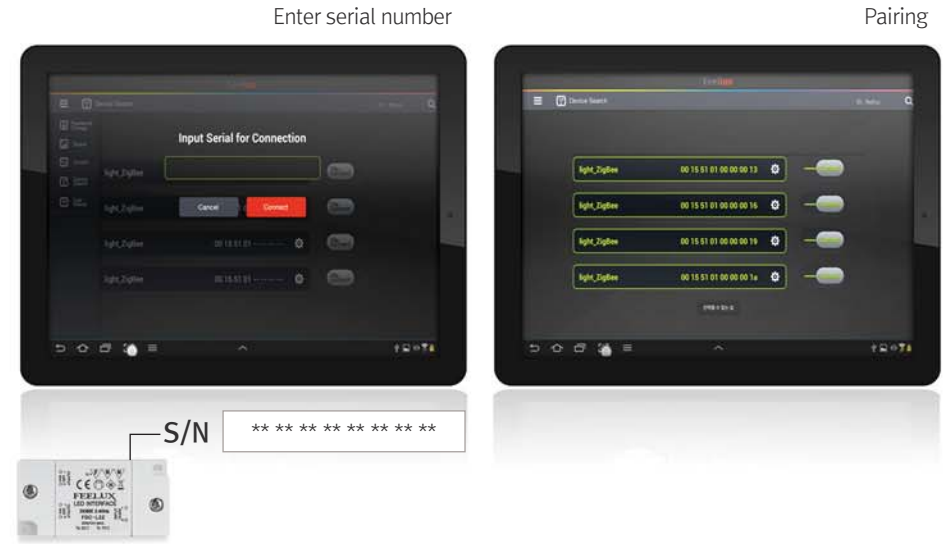

Step 4.

After pairing, set & save each scene as you desire.



Feelmaster

A mini magic controller in your hand



1. Individual Lighting Control



2. Scene Setting



Feelmaster

All in one with easy access, Feelmaster

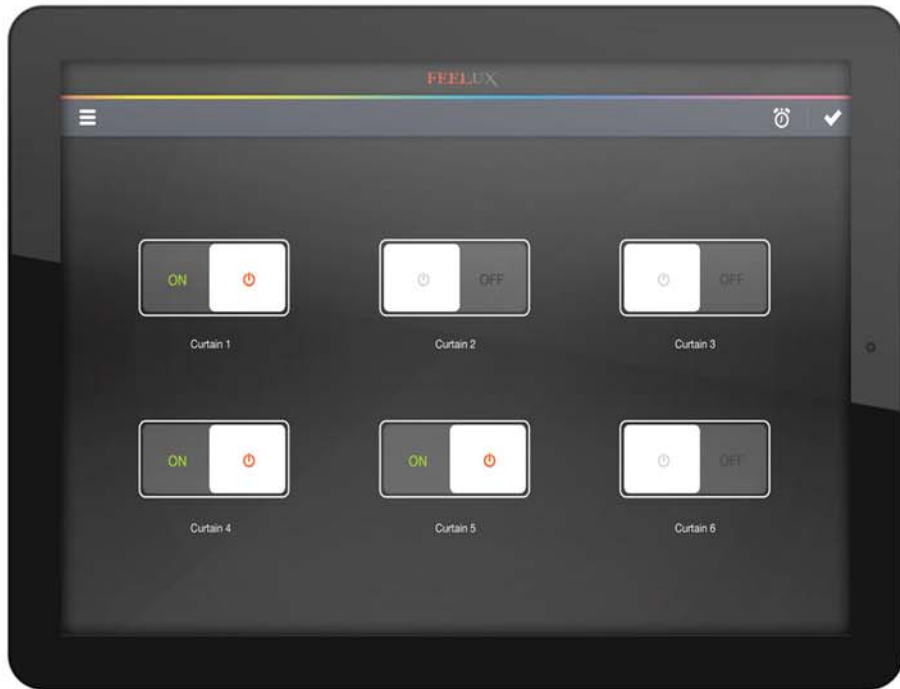

3. Curtain Control

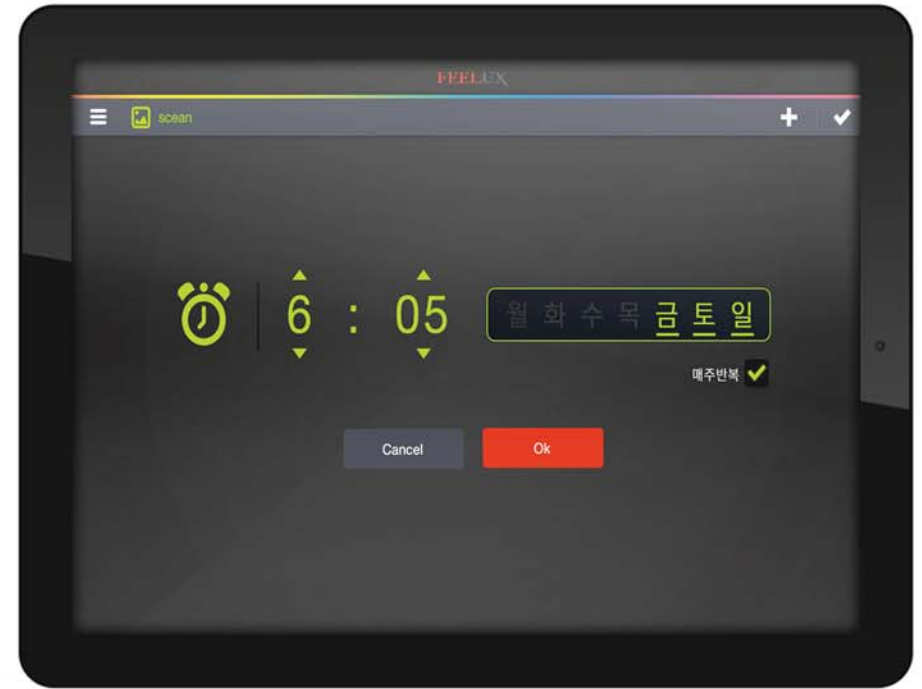

4. Scheduling



Feelmaster

Simple installation, Easy connection!



AC Lighting

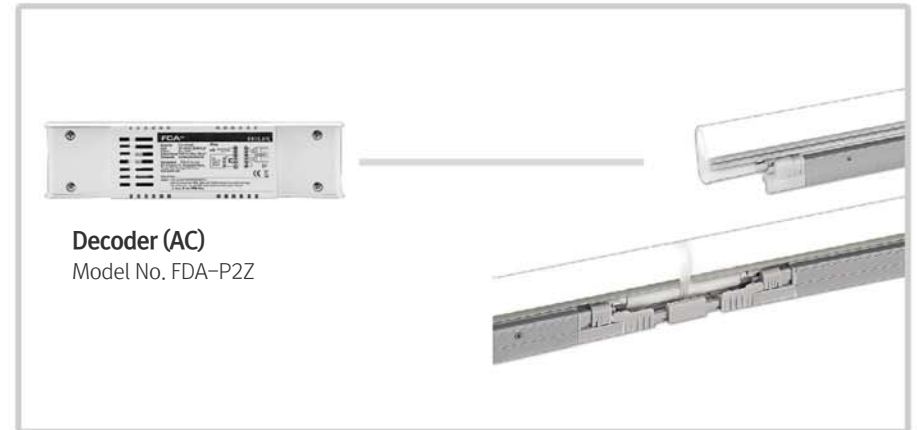

Decoder (AC)
Model No. FDA-P2Z

DC Lighting

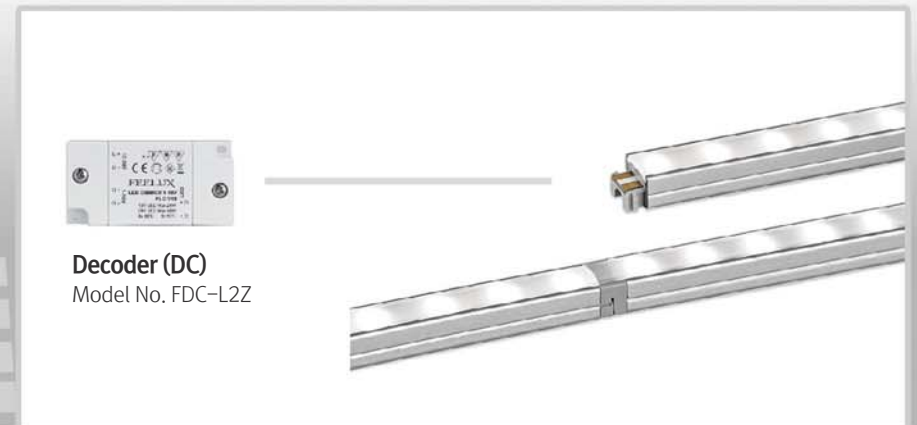

Decoder (DC)
Model No. FDC-L2Z

Feelmaster

Wire hassle-free



Zigbee



Curtain Decoder
Model No. FDA-C2Z

Feelmaster

Specification

Feelmaster

Model name	FM-IA2400
Each channel	Max 56 channel
Support controller	
WAN	1 Port, 10/100 Base-T, RJ45
LAN	1 Port, 10/100 Base-T, RJ45
WIFI	Compliant to IEEE802.11 b/g/n
Zigbee	Compliant to IEEE802.15.4
FeelNet	1 Port (DMX512/RS485), RJ45
USB	USB2.0
Size	100(W) X 100(D) X 25(H) mm
Power	DC 24V



DC Decoder



Model name	FDC-L2Z
Input Voltage	DC 12V/24V
Output Voltage	DC 12V LED Max.50W (25W/CH) DC 24V LED Max.100W (50W/CH)
Input Signal	ZIGBEE
Channel	2CH
LAMP	DC 12V/24V LED
Dimension	W78 X H40 X D16



Model name	FDA-L2Z
Input Voltage	DC 12V/24V
Output Voltage	DC 12V LED Max.100W (50W/CH) DC 24V LED Max.200W (100W/CH)
Input Signal	ZIGBEE
Channel	2CH
LAMP	DC 12V/24V LED
Dimension	W200 X H50 X D35

AC Decoder



Model name	FDA-P2Z
Input Voltage	AC200-240V, 50/60Hz
Rated Output	MAX 400W/CH (MAX 10pcs/CH)
Input Signal	ZIGBEE
Channel	2CH
LAMP	Dim Slim/ Dim Slim Line
Dimension	W200 X H50 X D35

Curtain Decoder



Model name	FDA-C2Z
Input Voltage	AC200-240V, 50/60Hz
Input Signal	ZIGBEE
Output Type	Control Feelux Curtain Only
Channel	2CH
Dimension	W200 X H50 X D35

FEELUX

WWW.FEELUX.COM

235-48, Gwangjeok-ro, Gwangjeok-myeon, Yangju-si, Gyeonggi-do, Korea
TEL +82-70-7780-8200 FAX +82-70-7780-8209 E-mail info@feelux.com

